

## WP 3 / Activity 3.3

# Global Finite Element Strength Analysis of Double-Ended Ferry

Prepared by:

University of Rijeka - Faculty of Engineering

Tehnomont Shipyard Pula Ltd

## Summary

<b>1. INTRODUCTION / METHODOLOGY.....</b>	<b>3</b>
<b>2. PRELIMINARY STRUCTURAL DESIGN.....</b>	<b>4</b>
2.1 Background .....	4
2.2 Scantlings calculations .....	6
<b>3. GLOBAL FE STRENGTH ANALYSIS .....</b>	<b>18</b>
3.1 Ship particulars.....	18
3.2 Referential Documents and 3D Model Description.....	19
3.2.1 Referential Documents.....	19
3.2.2 Model description .....	20
3.2.3 Scantlings.....	22
3.2.4 Material properties.....	23
3.2.5 Modelling of loads .....	23
3.3 FE Modelling Characteristics.....	27
3.4 Calculation Data and Assumption .....	29
3.4.1 Boundary condition.....	29
3.4.2 Loading conditions .....	30
3.4.3 Calculation assumptions.....	32
3.5 Results .....	32
3.5.1 Simulation 1.1.....	33
3.5.2 Simulation 1.2.....	39
3.5.3 Simulation 1.3.....	46
3.5.4 Simulation 2.1.....	53
3.5.5 Simulation 2.2.....	61
3.5.6 Simulation 2.3.....	69

3.5.7	Simulation 3.1.....	77
3.5.8	Simulation 3.2.....	88
3.5.9	Simulation 3.3.....	98
<b>4.</b>	<b>SIDE AND SUPERSTRUCTURE EFFICIENCY ANALYSIS.....</b>	<b>108</b>
4.1	Background for comparison.....	108
4.2	Structural elements strength comparison .....	109
<b>5.</b>	<b>CONCLUSION .....</b>	<b>112</b>
	<b>REFERENCES .....</b>	<b>113</b>

## 1. INTRODUCTION / METHODOLOGY

This document represents the second part of the work of structural analysis of double ended ferries with the aim of verifying the calculated scantlings of the hull and superstructure. The first part of the work was related to the development of a geometric model of the structure (see document *Double ended Ferry Structural Model*) after the defined hull form and basic structural configuration within the conceptual design [1]. This second part begins with defining the dimensions of the structural elements on the midship section through the 'classification' drawing (document *METRO-double-ended ferry-1200301-REV1-Midship section preliminary*). Since the project did not envisage the preparation of hull classification documentation, and therefore no drawings such as *Shell expansion, Decks plans, Watertight and longitudinal bulkheads, Engine room structure, Superstructure*, etc.) it was necessary to determine the preliminary dimensions of the structure of other parts of the hull and superstructure outside the midship. This problem was solved by using the classification society Bureau Veritas software package MARS2000, which using the rules and regulations of the same classification society provides for class [2], supervision and possible construction, and which are integrated into the software package. All in order to determine the scantlings of the remaining part of the hull structure. This was done in such a way that the minimum required dimensions were determined for additional cross-sections with regard to the requirements such as longitudinal strength, minimum section modulus of cross-sections, minimum structural dimensions, as well as checking of structural elements against buckling. After that, the geometric model could be meshed and the elements could be given specific dimensions in terms of material type, as well as scantlings for plating thickness and dimensions of stiffeners based on their actual section modulus of cross section. After meshing and defining the physical properties of the material, the boundary conditions and the modelled load were determined. The real load modelling approach was used, which included modelling the hydrostatic load according to the actual draught, and the load from the vehicle for the specific loading condition. Hydrodynamic analysis as well as accelerations were not considered. A static analysis was performed in the elastic region using the LS-DYNA software package, [3], based on FEM, [4], [5]. Through analysis, the three most unfavourable loading conditions were observed, according to the recommendations of the classification society. Additionally, the possible influence of the superstructure above the main deck on the longitudinal strength was observed, so an additional division into three structural models was made. The first model included the structure up to the main deck, the second model included the side above the main deck up to and including the passenger deck, and the third model included the complete hull with the superstructure to the wheelhouse. The idea is to evaluate the efficiency of the superstructure with the aim of reducing the dimensions of the hull by monitoring the stresses in individual elements through all three combinations of hulls. Namely, classification societies generally do not recognize the positive influence of superstructures on the reduction of normal (or

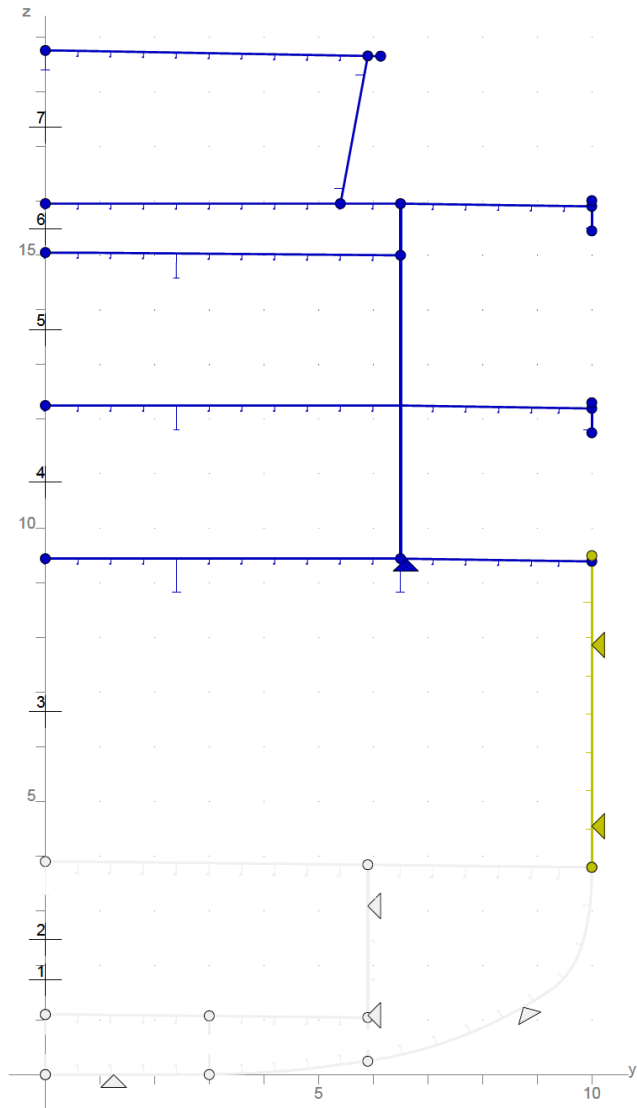
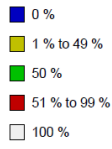


equivalent) stresses through basic expressions for dimensioning structural elements, but it is necessary to prove the same by direct calculation method such as FEA. This is presented at the level of the results of the global strength analysis with the possibility of further optimization in the next step of the design spiral, i.e. the development of basic design, [6], [7].

## 2. PRELIMINARY STRUCTURAL DESIGN

### 2.1 Background

In order to model the structure within the *FEA* procedure, it is necessary to determine the dimensions of all structural elements. The standard design procedure, [8], [9] would include the production of basic classification drawings of the structure from which all dimensions of the primary and secondary hull elements can be listed. As this was not the case within this project, the scantlings of the structural elements on the midship section (midship section preliminary draft) were first determined on the basis of the trim and stability book document over the longitudinal strength calculation. Input data for scantlings calculation are still water bending moment obtained from the mentioned calculation/document and wave vertical bending moment determined according to the rules and regulations of BV classification society [2] and are shown in Table 1. With the remaining data on material type (MS) and yield strength ( $\sigma_y$ ) with the use of the above rules and regulations, the minimum structural dimensions on the midship section is determined, which in the assumed structural arrangement meet the required minimum section modulus of the midship section and are shown in Table 2 and Figure 3. Within yellow frames, on Figure 3, plating thickness in millimetres and, on the left side, the required scantlings of the girders and stiffeners are given. As the load varies along the length of the ship, it was necessary to repeat this procedure for a number of characteristic cross-sections in order to obtain the dimensions for the structure model and FEA as accurately as possible. The sections considered are: FR60, FR43, FR32, FR25 and respectively the input data are shown in Tables 3, 5, 7 and 9, and the results in Tables 4, 6, 8 and 10 and in Figures 3, 4, 5 and 6. In addition, it should be noted that the dimensions are determined for the low efficiency of the superstructure in longitudinal strength, Figure 1. This was later investigated in more detail through three different models of the hull and part of the superstructure (see Chapter 4). The aim was to point out the possible stronger positive influence of the superstructure on the longitudinal strength, which can be proven only by direct calculation methods (FEM) and presentation to the classification society as a possible basis for optimizing the dimensions of hull structure elements.



**Figure 1** *Midship section bending efficiency*

## 2.2. Scantlings calculation

### Midship Section

**Table 1 Hull girder loads**

Vertical Bending Moment		
	Hogging (kNm)	Sagging (kNm)
S.W.B.M. Builder's proposal in Basic Ship Data .....	47 000.	- 1 000.
S.W.B.M. Builder's proposal at X = 46.35 m .....	-	-
S.W.B.M. preliminary value at midship .....	141 427.	- 113 018.
S.W.B.M. preliminary value at X = 46.35 m .....	141 427.	- 113 018.
Rule Vertical Wave Bending Moment at X = 46.35 m ..	114 693.	- 143 102.
<b>Design Hull Girder Loads at X = 46.35 m</b>		
	Hogging (kNm)	Sagging (kNm)
S.W.B.M. ....	47 000.	- 1 000.
Wave bending moment (Rule) .....	114 693.	- 143 102.
Horizontal wave bending moment .....	19 670.	
	Positive (KN)	Negative (KN)
Vertical still water shear force .....	1 800.	
Vertical wave shear force .....	3 038.	- 3 038.
<b>Admissible Vertical Shear Forces</b>		
Total Admissible Vert. Shear Force .....	(KN) .....	9 880.
Positive Admissible Vert. Still Water Shear Force .....	(KN) .....	6 842.
Negative Admissible Vert. Still Water Shear Force .....	(KN) .....	6 842.

**Table 2 Section modulus of inertia**

Minimum section modulus at midship section ( $k = 1, n_1 = 0.9$ ) .....	1.4635 (m <sup>3</sup> )		
<b>Rule section moduli</b>			
	Deck (m <sup>3</sup> )	Bottom (m <sup>3</sup> )	Top (m <sup>3</sup> )
Modulus based on design BM, Hog. ( 161 692.5 kNm) .....	0.9240	0.9240	0.9240
Modulus based on design BM, Sag. (- 144 101.6 kNm) .....	0.8234	0.8234	0.8234
Rule Modulus .....	0.9240	0.9240	0.9240
<b>Check of section moduli and inertia</b>			
	Rule	Actual	
Deck ( 3.800 m $k = 1.00$ )	0.9240	1.4481	
Bottom ( 0.000 m $k = 1.00$ )	0.9240	1.1027	
Top ( 9.500 m $k = 1.00$ )	0.9240	0.3240 *	
Inertia	3.5094	2.3788	
* Actual section modulus or inertia does not comply with rule value			
<b>Check of Net/Gross Moduli</b>			
	Actual Gross	Actual Net	%
Deck ( 3.800 m) .....	1.4481	1.3113	90.6
Bottom ( 0.000 m) .....	1.1027	0.9919	90.0
Top ( 9.500 m) .....	0.3240	0.2925	90.3

Axis - Stiffeners - Welding joints - Strakes - Transverse stiffening

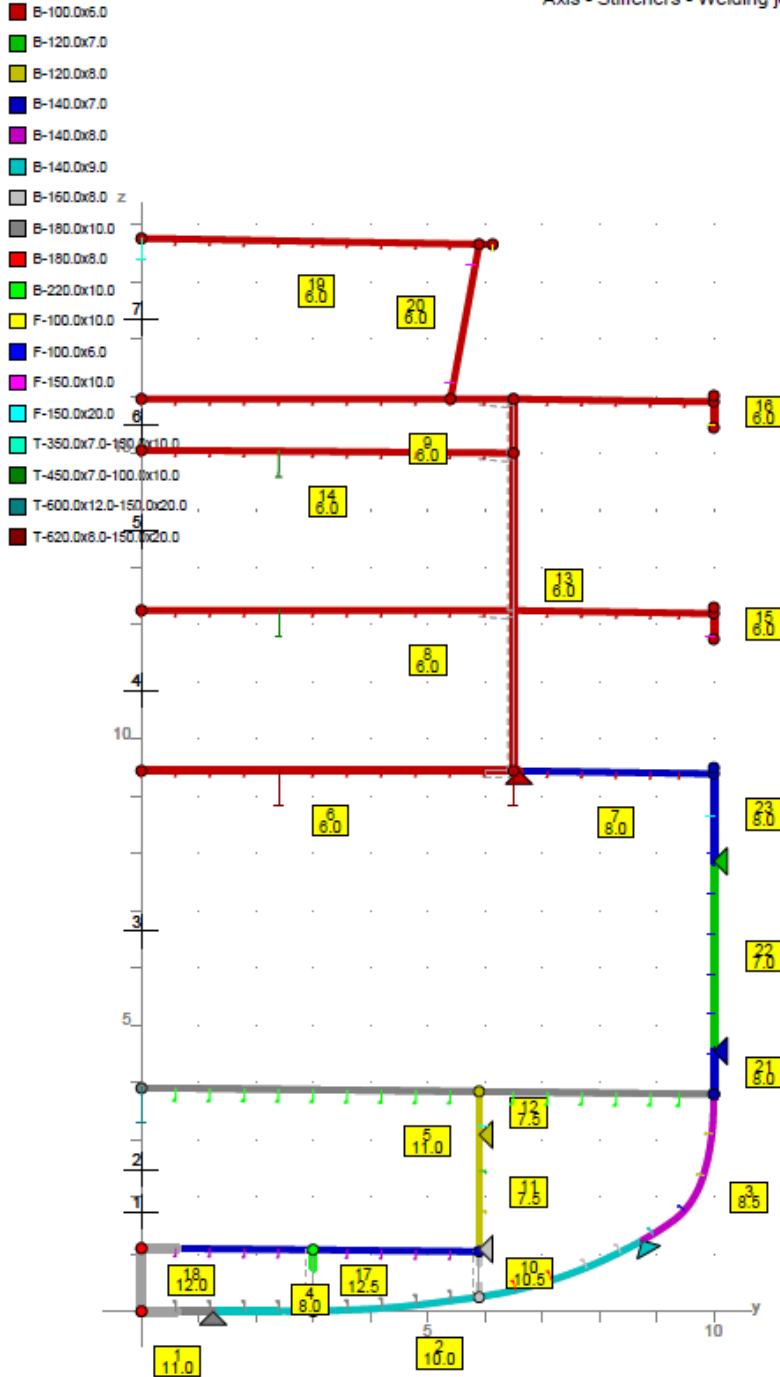


Figure 2 Plating and stiffeners scantlings on Midship Section

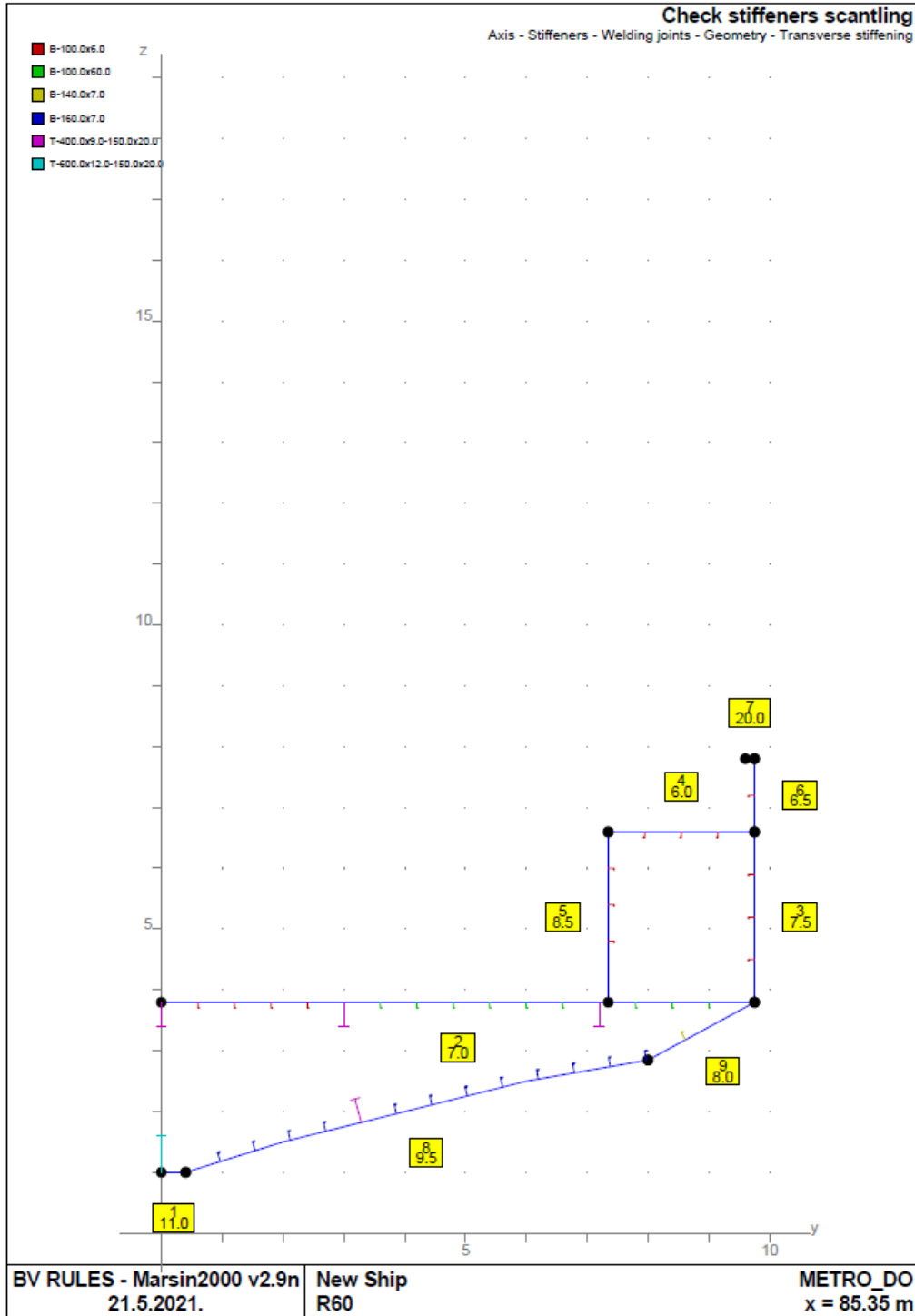
Frame 60

**Table 3 Hull girder loads**

Vertical Bending Moment		
	Hogging (kNm)	Sagging (kNm)
S.W.B.M. Builder's proposal in Basic Ship Data	47 000.	- 1 000.
S.W.B.M. Builder's proposal at X = 85.35 m	-	-
S.W.B.M. preliminary value at midship	141 427.	- 113 018.
S.W.B.M. preliminary value at X = 85.35 m	47 453.	- 37 921.
Rule Vertical Wave Bending Moment at X = 85.35 m	16 654.	- 20 780.
Design Hull Girder Loads at X = 85.35 m		
	Hogging (kNm)	Sagging (kNm)
S.W.B.M.	15 770.	- 336.
Wave bending moment (Rule)	16 654.	- 20 780.
Horizontal wave bending moment	2 856.	
	Positive (KN)	Negative (KN)
Vertical still water shear force	1 000.	
Vertical wave shear force	1 471.	- 1 179.
Admissible Vertical Shear Forces		
Total Admissible Vert. Shear Force	(KN)	4 318.
Positive Admissible Vert. Still Water Shear Force	(KN)	2 847.
Negative Admissible Vert. Still Water Shear Force	(KN)	3 139.

**Table 4 Section modulus and inertia**

Minimum section modulus at midship section ( $k = 1, n_1 = 0.9$ )	1.4635 (m <sup>3</sup> )		
Rule section moduli			
	Deck (m <sup>3</sup> )	Bottom (m <sup>3</sup> )	Top (m <sup>3</sup> )
Modulus based on design BM, Hog. ( 32 424.1 kNm)	0.2594	0.2594	0.2594
Modulus based on design BM, Sag. (- 21 115.1 kNm)	0.1689	0.1689	0.1689
Rule Modulus	0.2594	0.2594	0.2594
Check of section moduli and inertia			
	Rule	Actual	
Deck ( 2.800 m k = 1.00)	0.2594	-2.1428	
Bottom ( 1.000 m k = 1.00)	0.2594	0.2732	
Top ( 7.800 m k = 1.00)	0.2594	0.1190 *	
Inertia	3.5094	0.5636	
* Actual section modulus or inertia does not comply with rule value			
Check of Net/Gross Moduli			
	Actual Gross	Actual Net	%
Deck ( 2.800 m)	-2.1428	-1.8985	88.6
Bottom ( 1.000 m)	0.2732	0.2445	89.5
Top ( 7.800 m)	0.1190	0.1067	89.7



**Figure 3** *Plating and stiffeners scantlings on FR60*

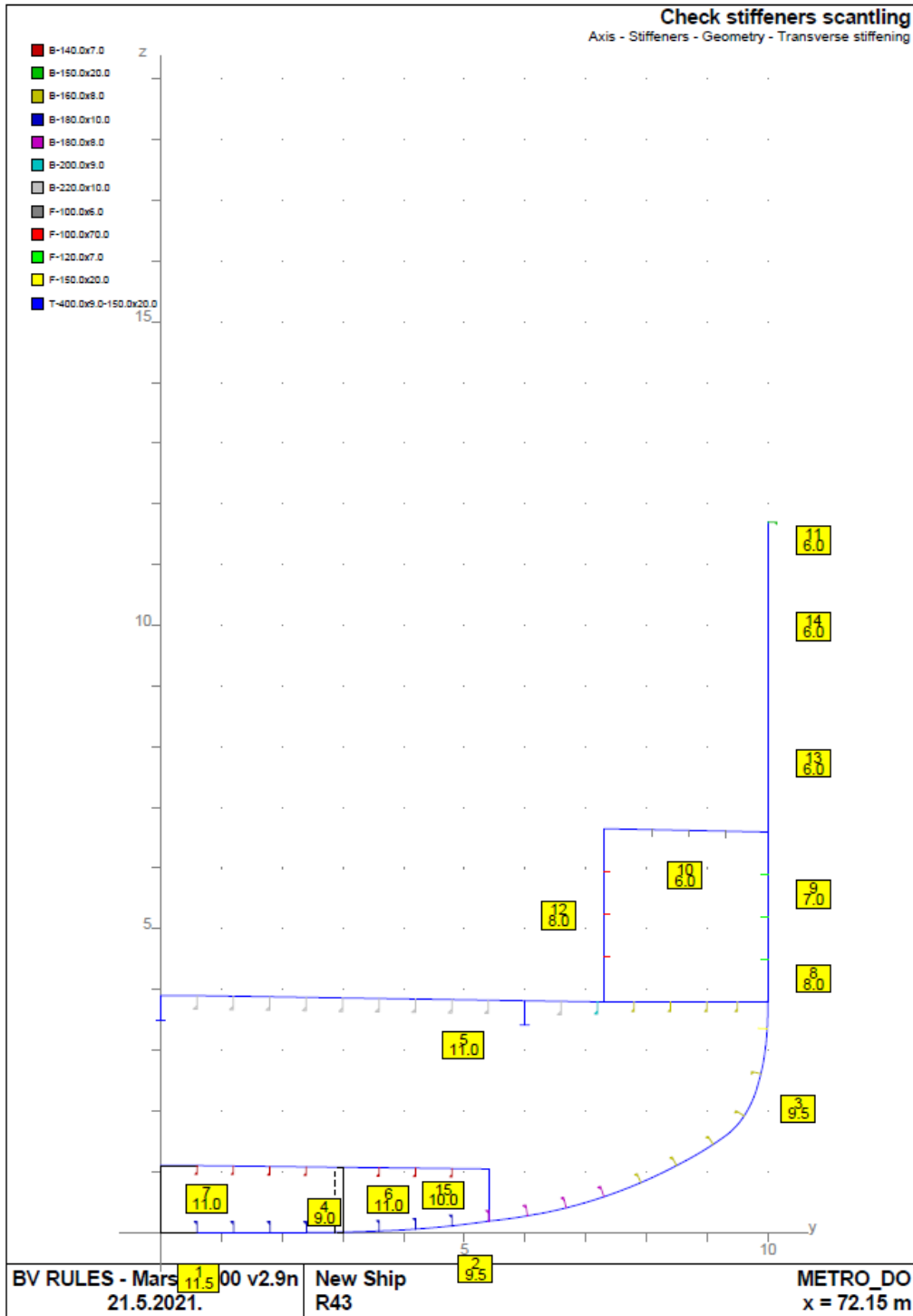
Frame 43

**Table 5 Hull girder loads**

Vertical Bending Moment		
	Hogging (kNm)	Sagging (kNm)
S.W.B.M. Builder's proposal in Basic Ship Data .....	47 000.	- 1 000.
S.W.B.M. Builder's proposal at X = 72.15 m .....	-	-
S.W.B.M. preliminary value at midship .....	141 427.	- 113 018.
S.W.B.M. preliminary value at X = 72.15 m .....	102 816.	- 82 162.
Rule Vertical Wave Bending Moment at X = 72.15 m ...	64 759.	- 80 799.
<b>Design Hull Girder Loads at X = 72.15 m</b>		
	Hogging (kNm)	Sagging (kNm)
S.W.B.M. ....	34 168.	- 727.
Wave bending moment (Rule) .....	64 759.	- 80 799.
Horizontal wave bending moment .....	11 106.	
	Positive (KN)	Negative (KN)
Vertical still water shear force .....	1 800.	
Vertical wave shear force .....	4 340.	- 3 479.
<b>Admissible Vertical Shear Forces</b>		
Total Admissible Vert. Shear Force .....	(KN) .....	7 192.
Positive Admissible Vert. Still Water Shear Force .....	(KN) .....	2 851.
Negative Admissible Vert. Still Water Shear Force .....	(KN) .....	3 713.

**Table 6 Section modulus and inertia**

Rule section moduli				
	Deck (m <sup>3</sup> )	Bottom (m <sup>3</sup> )	Top (m <sup>3</sup> )	
Modulus based on design BM, Hog. ( 98 927.1 kNm) .....	0.6621	0.6621	0.6621	
Modulus based on design BM, Sag. (- 81 526.3 kNm) .....	0.5457	0.5457	0.5457	
Rule Modulus .....	0.6621	0.6621	0.6621	
<b>Check of section moduli and inertia</b>				
		Rule	Actual	
Deck ( 3.800 m k = 1.00)		0.6621	1.1812	
Bottom ( 0.000 m k = 1.00)		0.6621	0.9826	
Top ( 6.600 m k = 1.00)		0.6621	0.4504 *	
Inertia		3.5094	2.0382	
* Actual section modulus or inertia does not comply with rule value				
<b>Check of Net/Gross Moduli</b>				
		Actual Gross	Actual Net	%
Deck ( 3.800 m) .....		1.1812	1.0729	90.8
Bottom ( 0.000 m) .....		0.9826	0.8655	88.1
Top ( 6.600 m) .....		0.4504	0.4048	89.9



**Figure 4** Plating and stiffeners scantlings on FR43



Frame 32

**Table 7 Hull girder loads**

Vertical Bending Moment		
	Hogging (kNm)	Sagging (kNm)
S.W.B.M. Builder's proposal in Basic Ship Data .....	47 000.	- 1 000.
S.W.B.M. Builder's proposal at X = 65.55 m .....	-	-
S.W.B.M. preliminary value at midship .....	141 427.	- 113 018.
S.W.B.M. preliminary value at X = 65.55 m .....	130 497.	- 104 283.
Rule Vertical Wave Bending Moment at X = 65.55 m ...	88 811.	- 110 809.
Design Hull Girder Loads at X = 65.55 m		
	Hogging (kNm)	Sagging (kNm)
S.W.B.M. ....	43 368.	- 923.
Wave bending moment (Rule) .....	88 811.	- 110 809.
Horizontal wave bending moment .....	15 231.	
	Positive (KN)	Negative (KN)
Vertical still water shear force .....	1 800.	
Vertical wave shear force .....	4 340.	- 3 479.
Admissible Vertical Shear Forces		
Total Admissible Vert. Shear Force .....	(KN) .....	9 426.
Positive Admissible Vert. Still Water Shear Force .....	(KN) .....	5 086.
Negative Admissible Vert. Still Water Shear Force .....	(KN) .....	5 948.

**Table 8 Section modulus and inertia**

Rule section moduli			
	Deck (m <sup>3</sup> )	Bottom (m <sup>3</sup> )	Top (m <sup>3</sup> )
Modulus based on design BM, Hog. ( 132 178.5 kNm) .....	0.7879	0.7879	0.7879
Modulus based on design BM, Sag. (- 111 731.9 kNm) .....	0.6660	0.6660	0.6660
Rule Modulus .....	0.7879	0.7879	0.7879
Check of section moduli and inertia			
	Rule	Actual	
Deck ( 3.800 m k = 1.00)	0.7879	1.3780	
Bottom ( 0.000 m k = 1.00)	0.7879	1.0092	
Top ( 9.400 m k = 1.00)	0.7879	0.3072 *	
Inertia	3.5094	2.2137	
* Actual section modulus or inertia does not comply with rule value			
Check of Net/Gross Moduli			
	Actual Gross	Actual Net	%
Deck ( 3.800 m) .....	1.3780	1.2422	90.1
Bottom ( 0.000 m) .....	1.0092	0.8971	88.9
Top ( 9.400 m) .....	0.3072	0.2752	89.6

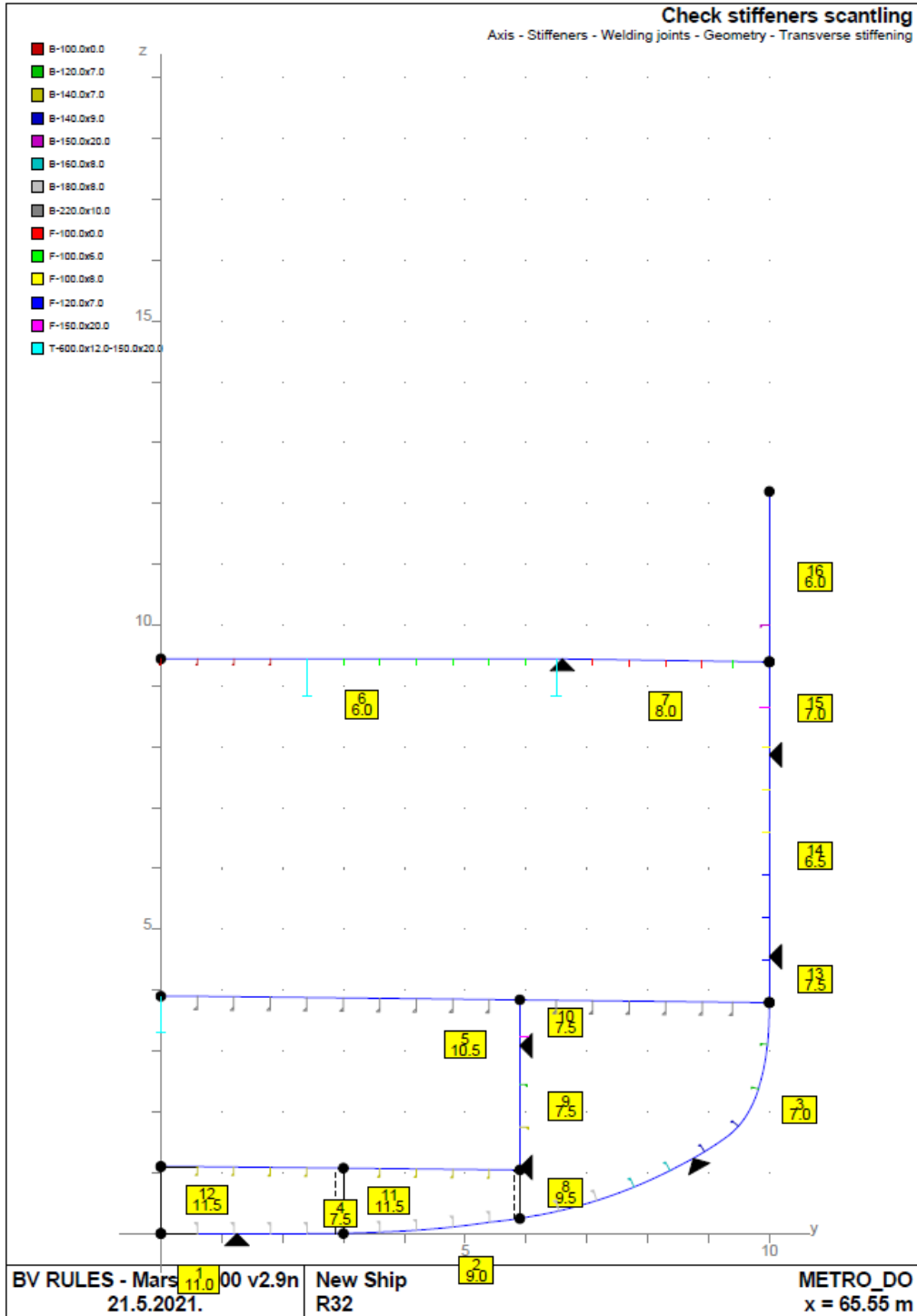


Figure 5 Plating and stiffeners scantlings on FR32

Frame 25

**Table 9 Hull girder loads**

Vertical Bending Moment		
	Hogging (kNm)	Sagging (kNm)
S.W.B.M. Builder's proposal in Basic Ship Data .....	47 000.	- 1 000.
S.W.B.M. Builder's proposal at X = 61.35 m .....	-	-
S.W.B.M. preliminary value at midship .....	141 427.	- 113 018.
S.W.B.M. preliminary value at X = 61.35 m .....	141 427.	- 113 018.
Rule Vertical Wave Bending Moment at X = 61.35 m ..	104 117.	- 129 906.
Design Hull Girder Loads at X = 61.35 m		
	Hogging (kNm)	Sagging (kNm)
S.W.B.M. ....	47 000.	- 1 000.
Wave bending moment (Rule) .....	104 117.	- 129 906.
Horizontal wave bending moment .....	17 856.	
	Positive (KN)	Negative (KN)
Vertical still water shear force .....	1 800.	
Vertical wave shear force .....	4 109.	- 3 401.
Admissible Vertical Shear Forces		
Total Admissible Vert. Shear Force .....	(KN) .....	9 836.
Positive Admissible Vert. Still Water Shear Force .....	(KN) .....	5 727.
Negative Admissible Vert. Still Water Shear Force .....	(KN) .....	6 436.

**Table 10 Section modulus and inertia**

Rule section moduli			
	Deck (m <sup>3</sup> )	Bottom (m <sup>3</sup> )	Top (m <sup>3</sup> )
Modulus based on design BM, Hog. ( 151 116.8 kNm) .....	0.8635	0.8635	0.8635
Modulus based on design BM, Sag. (- 130 906.4 kNm) .....	0.7480	0.7480	0.7480
Rule Modulus .....	0.8635	0.8635	0.8635
Check of section moduli and inertia			
	Rule	Actual	
Deck ( 3.800 m k = 1.00)	0.8635	1.4297	
Bottom ( 0.000 m k = 1.00)	0.8635	1.0777	
Top ( 9.400 m k = 1.00)	0.8635	0.3228 *	
Inertia	3.5094	2.3352	
* Actual section modulus or inertia does not comply with rule value			
Check of Net/Gross Moduli			
	Actual Gross	Actual Net	%
Deck ( 3.800 m) .....	1.4297	1.2942	90.5
Bottom ( 0.000 m) .....	1.0777	0.9676	89.8
Top ( 9.400 m) .....	0.3228	0.2912	90.2

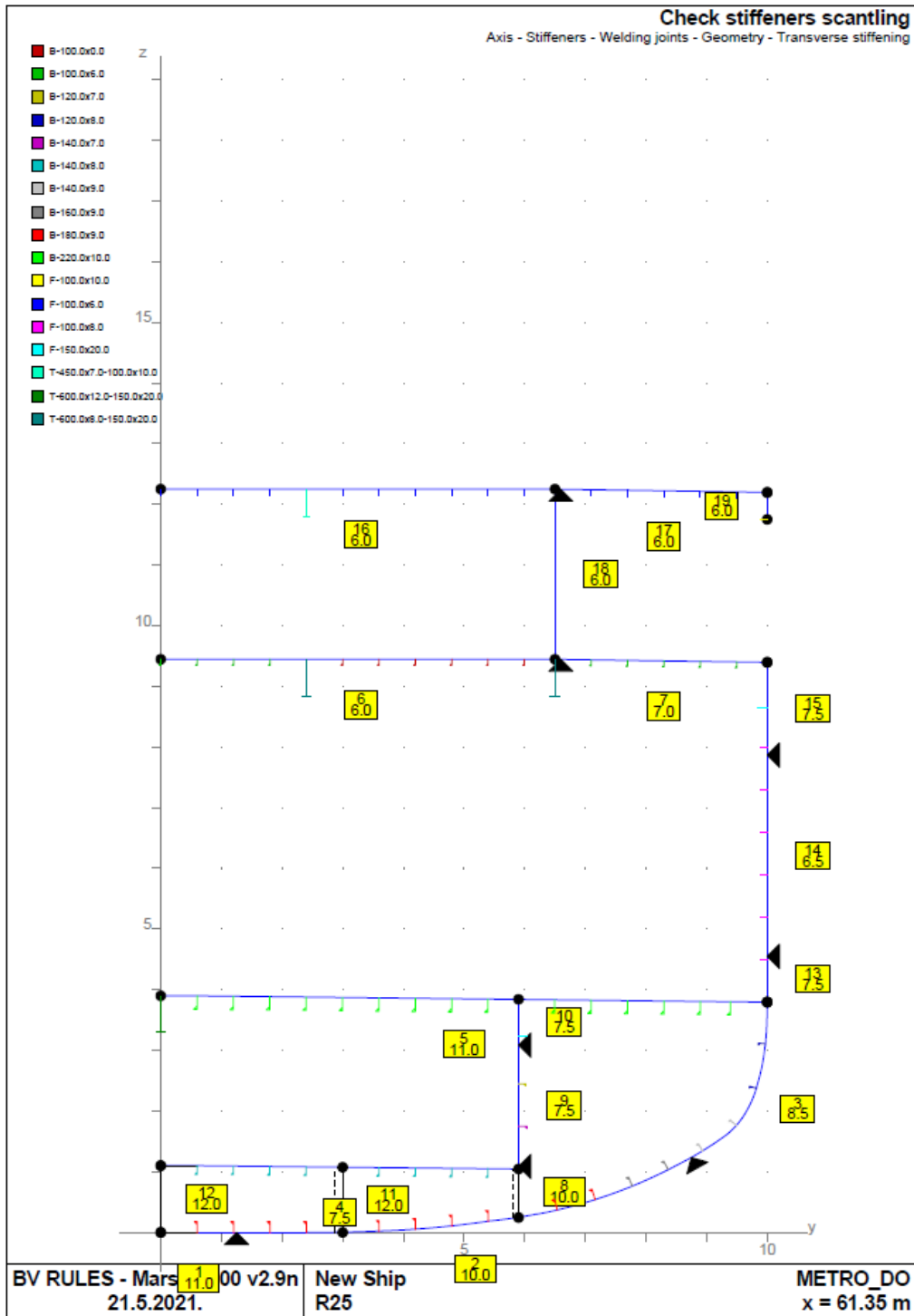
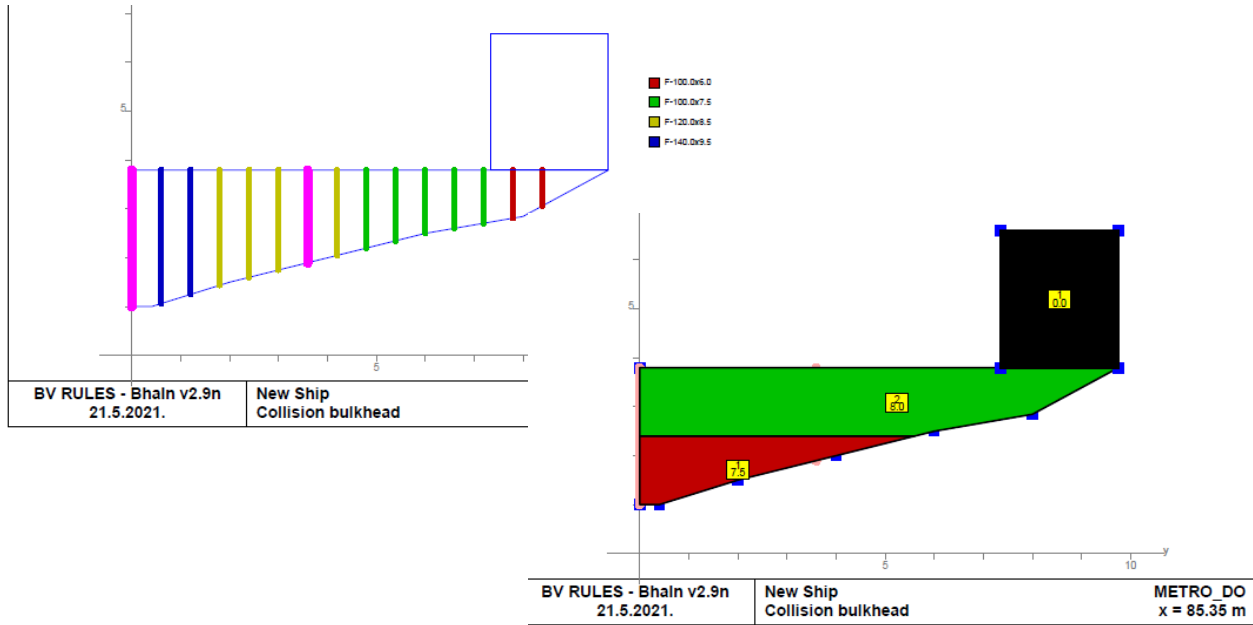
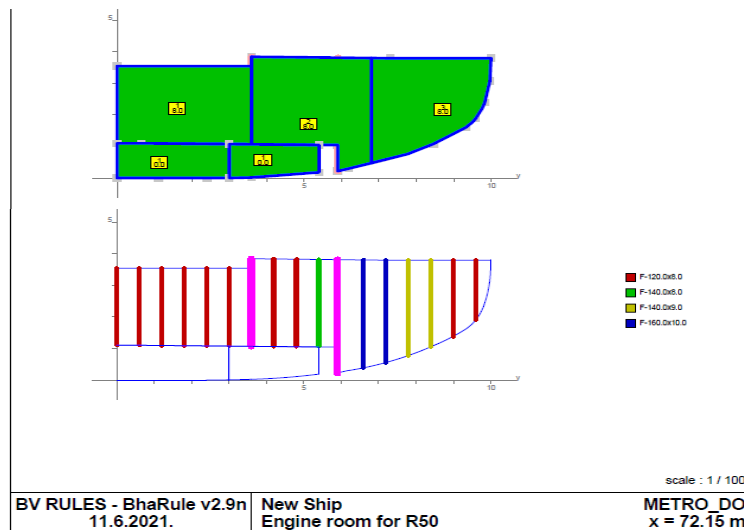


Figure 6 Plating and stiffeners on FR25

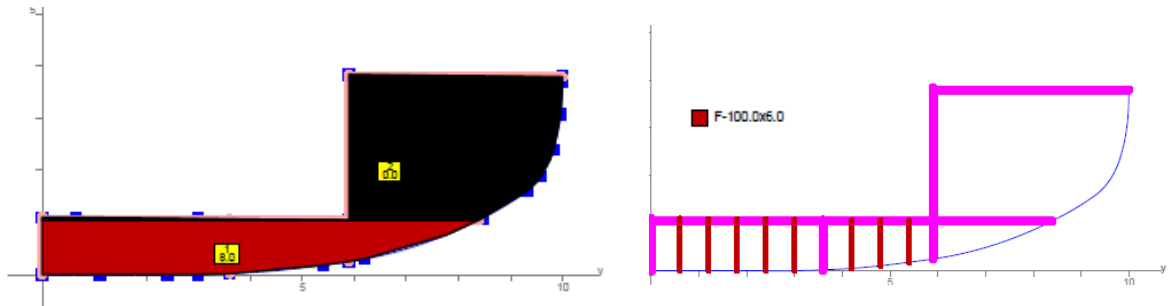
The resulting scantlings of the plating and stiffening of transverse structural elements such as the bow collision bulkhead (FR25) are shown in Figure 7, the watertight bulkheads of the engine room (FR50), Figure 8, and the solid floor on the midship section, Figure 9.



**Figure 7** *Plating and stiffeners on collision bulkhead on FR25*



**Figure 8** *Plating and stiffeners scantlings on engine room watertight bulkhead on FR50*



**Figure 9** *Plating and stiffeners scantlings on solid floor at midship section*

### 3. GLOBAL FE STRENGTH ANALYSIS

#### 3.1. Ship particulars

**Table 11** *Double ended ferry main particulars*

Length, overall	101.90	m
Length, between perpendiculars	92.70	m
Breadth, moulded	20.00	m
Hull depth to lower car deck (midship)	1.05	m
Hull depth to upper car deck (midship)	3.80	m
Draught, max(hull)	2.50	m
Draught, design (hull) abt.	2.30	m
Air draught	abt.25.00	m
Deadweight (at max. draught)	abt.1000	t
Deadweight (at design. draught)	abt.660	t
Gross tonnage	4860	GT
Design speed (design draught)	abt.10	knots
Maximum speed (design draught)	abt.12	knots

## 3.2. Referential Documents and 3D Model Description

A list of the main documents used for this report, follows below.

### 3.2.1. Referential Documents

The project state has been defined according to the following drawings:

Technical description: METRO-Double ended Ferry-Outline specification\_REV2

General Arrangement Plan: METRO-DoubleEndedFerry-1101302-REV2-GAP

Body Lines: METRO-DoubleEndedFerry-1101301-REV2-Body Lines

Midship Section: METRO-double ended ferry-1200301-REV1-Midship section preliminary

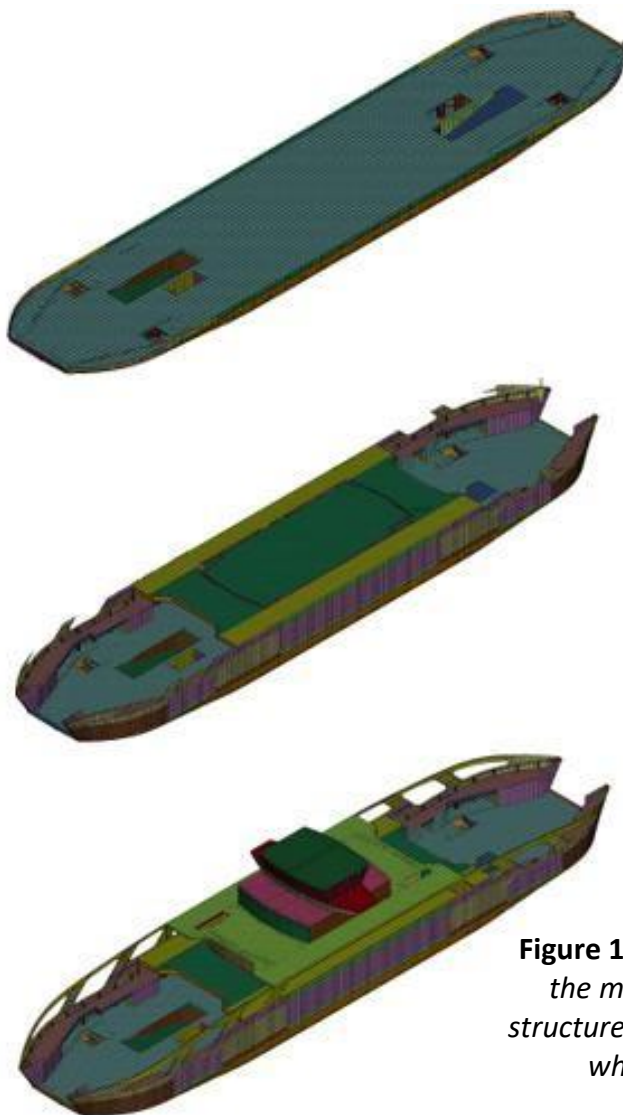
METRO-Double ended Ferry-TRIM & STABILITY BOOK\_REV1

METRO-Double ended Ferry-Weight estimation\_REV2



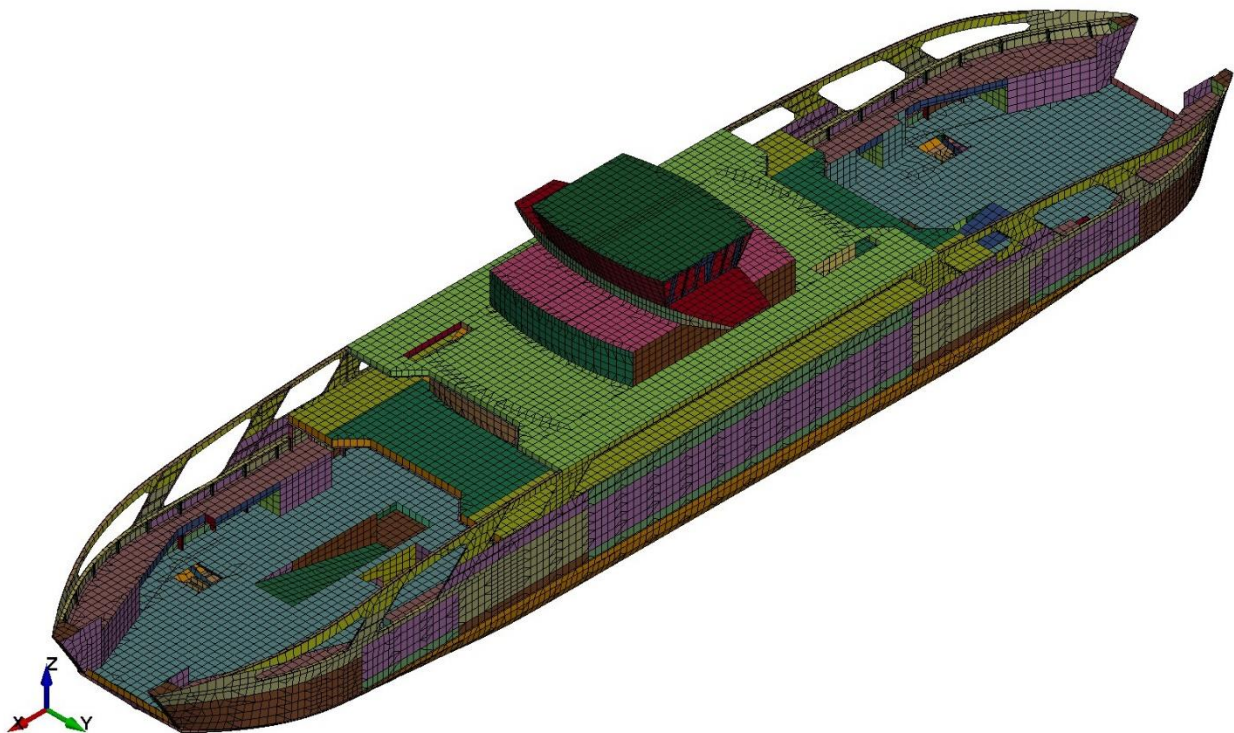
### 3.2.2. Model description

Complete structure model (CSM) of Double ended ferry is created for the simulation purposes, Figure 10 according to classification society recommendations [10], with three different models' variations. First model (*Model 1*) is created with structure up to the Main deck, as can be seen on the Figure 10, top. Next model (*Model 2*) is developed on the base of the *Model 1*. Unlike *Model 1*, *Model 2* has all additional structure that is between Main deck and Passenger deck, which includes Mooring deck and Passenger deck with their supporting structure, Figure 10, *middle*. Lastly, *Model 3*, represents whole ship, or in another words, rest of the structure above Passenger deck is added in the model.



**Figure 10** *Model 1* with the structure up to the main deck (top), *Model 2* with the structure up to the Passenger deck (middle), whole model, *Model 3* (bottom)

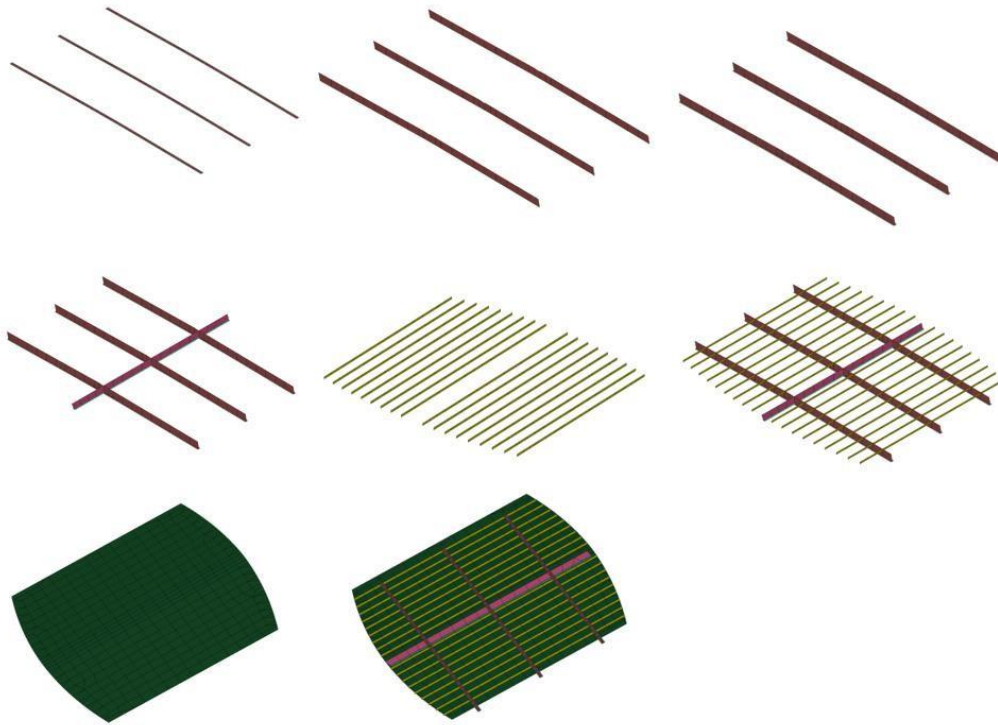
All three models are positioned in the working space (*FEM environment*) according to standard naval architectural practices in which x-axis is oriented aft to the fore in the longitudinal direction, y axis is oriented from starboard to the portside with its origin at the centreline of the vessel and z axis is oriented vertically to the base line of the ship with its positive direction from base to the top part of the ship. On the Figure 11 Model 3 is represented with coordinate system which in this case is not placed in its origin, but can be used for better understanding of orientation.



**Figure 11** *Coordinate system of the models*

The position of the coordinate system origin is at the aft end of each model, at the base line and at the centreline of the ship.

Model consists of 250 different parts, in which each part represents one structural element or in some cases a group of same structural elements. For example, if whole deck has same thickness it will be one part, but if it has two different thicknesses in two different areas in that case it will consist of two parts in the FEM environment.

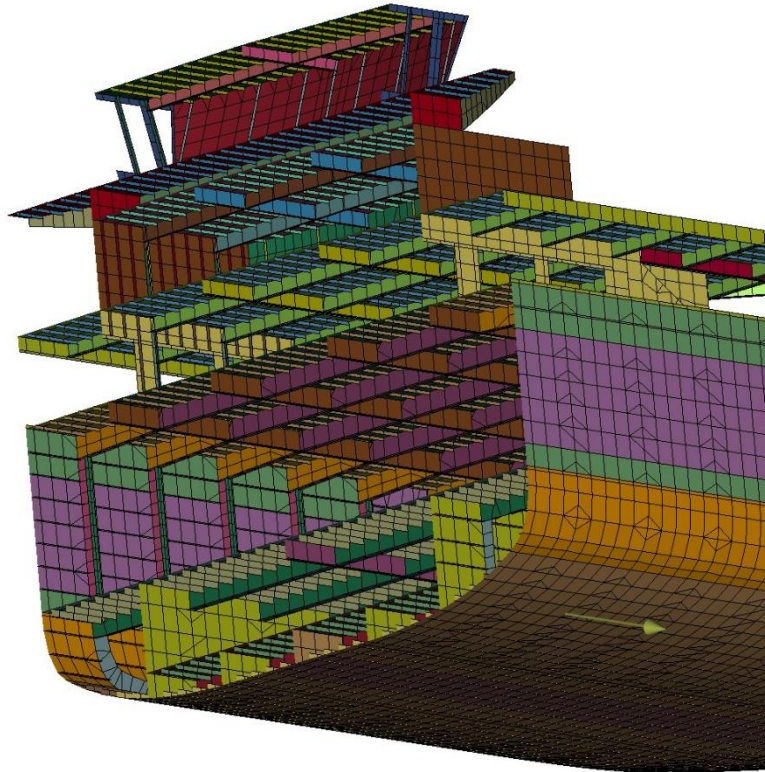


**Figure 12** Representation how separate parts (*gups*) are assembled into the deck with its structure

### 3.2.3. Scantlings

The structural arrangement follows documents listed in the “3.2.1. Referential Documents” and scantlings are followed from the calculations presented in the “2.2. Scantlings calculations”. Structure that is included in the model covers main structural elements as decks, bulkheads, girders and additional structural elements as deck stiffeners, bulkhead stiffeners, hull stiffeners and flanges on all girders. Example of the range of structural element that is included in the model and level of details can be seen on the Figure 13.





**Figure 13** *Transfers section view*

### 3.2.4. Material properties

One type of steel is used, with following properties:

- Young's modules:  $E = 201\ 000\ \text{MPa}$
- Poisson's ratio:  $\nu = 0.29$
- Yield stress  $\sigma_Y = 235\ \text{MPa}$

### 3.2.5. Modelling of loads

Presented and analysed Double ended ferry is Passenger / Ro-Ro types of ship that have such a shape and distribution of their own weight (quite uniform along the ship) that they are always in a hogging condition on calm water, i.e. they have extra buoyancy in the middle and weights at the ends. Due to such static load distribution, they are usually loaded with a very high bending moment on still water. The combination of the maximum still water bending moment and the maximum wave bending moment gives maximum longitudinal stresses. The

combination of the minimum bending moment on still water and the maximum wave bending moment gives the possibility of compressive stresses in the upper decks. This is to be avoided because the compressive stresses in the upper decks of the superstructure, which are mostly made of very thin plates (5-6 mm), can cause buckling problems. The shear force distribution on still water usually follows the theoretical distribution with maximum values in the range of about 0.25  $L$  and 0.75  $L$  of the stern vertical. Significant values of the shear force are obtained by summing the maximum value of the shear force due to the wave with the maximum value of the shear force on still water. This can cause large shear stresses on the side of the ship in areas of openings where shear stiffness is reduced, which is not the case of presented ferry.

Static load is divided into following groups:

- weight of structure, weight of paint, equipment, welds,
- weight of cargo per deck (usually default pressure per deck),
- cargo weight in cargo / ballast tanks,
- weight of supplies, fuel, lubricants, water,
- hydrostatic pressure due to buoyancy.

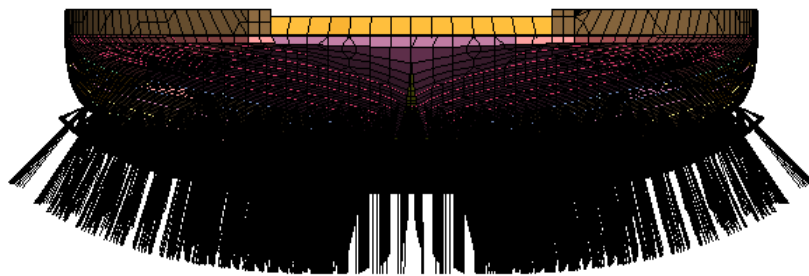
This phase of the project is accompanied by a detailed elaboration of Trim and Stability (T&S) book in which load cases of ship loading are defined (see 3.2.1 Referential Documents). The static load of an idealized structure is increased and adjusted to the weight of the light ship according to the T&S book for the considered loading case. The shape of the FE model quite faithfully follows the actual shape of the ship, and differences in displacement of up to 2% are considered acceptable [11]. The hydrostatic pressure distribution is directly defined by the ship's draft and have to be checked also. The load on the decks is explicitly given in the form of pressure. The weight of the cargo in the tanks is derived from the volume of the tank and the density of the liquid. For passenger and Ro-Ro ships, splashing and dynamic pressure distribution in tanks are not important. The mass of the main machine and larger equipment is defined at the exact position as concentrated mass. The self-weight of the idealized construction is calculated directly by FEM programs from the structural model. It is increased by the weight of the neglected reinforcement, welds, paint, small equipment, inventory, etc. The difference is defined by the magnification factor which increases the density of the steel. In this case, the total weight distribution follows the own weight distribution of the idealized structure. The magnification is obtained in parallel with the adjustment of the weight curve obtained from the FEM program and that from the T&S book. In this way, the load distribution of the 3D FE model of the whole ship, and thus the distribution of the static bending moment by amount, follows the one from the T&S book.

When modelling the wave load, it should be on mind that it is generated with much more uncertainty than the structural model, and therefore was not considered at this stage of the analysis. Direct methods for calculating the wave loads of various authors still give large

variations in the results of even the vertical wave moment [12]. For the practical implementation of wave loads on the 3D FE model of the whole ship, the design wave method [11] and [13] is usually used due to the speed and practicality of the calculation. They use elements of a deterministic and / or statistical approach in determining the equivalent design wave that will load the FE model.

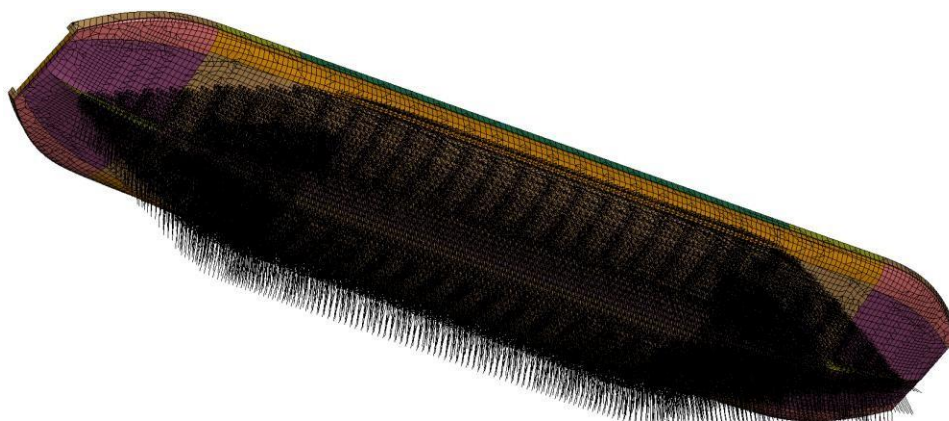
Three different loading cases were used in the simulations. In all simulations hydrostatic pressure was included which is changed depending on the draught. Second load case is with the cars as a cargo on the Main deck and a Tank top, and last case is with the trucks on the Main deck.

Hydrostatic load is set onto the hull surface in five separated areas. So, each draught that is implemented into the simulation is separated by height into five areas. For each areas pressure is calculated separately based on Bernoulli's equation. With explained approach hydrostatic load is set as distributed load on the hull surface which changes with the depth.



**Figure 14** *Hydrostatic load distribution on the hull surface, front view*

Hydrostatic load is modelled as a shell pressure.



**Figure 15** *Hydrostatic load distribution on the hull surface, isometric view*



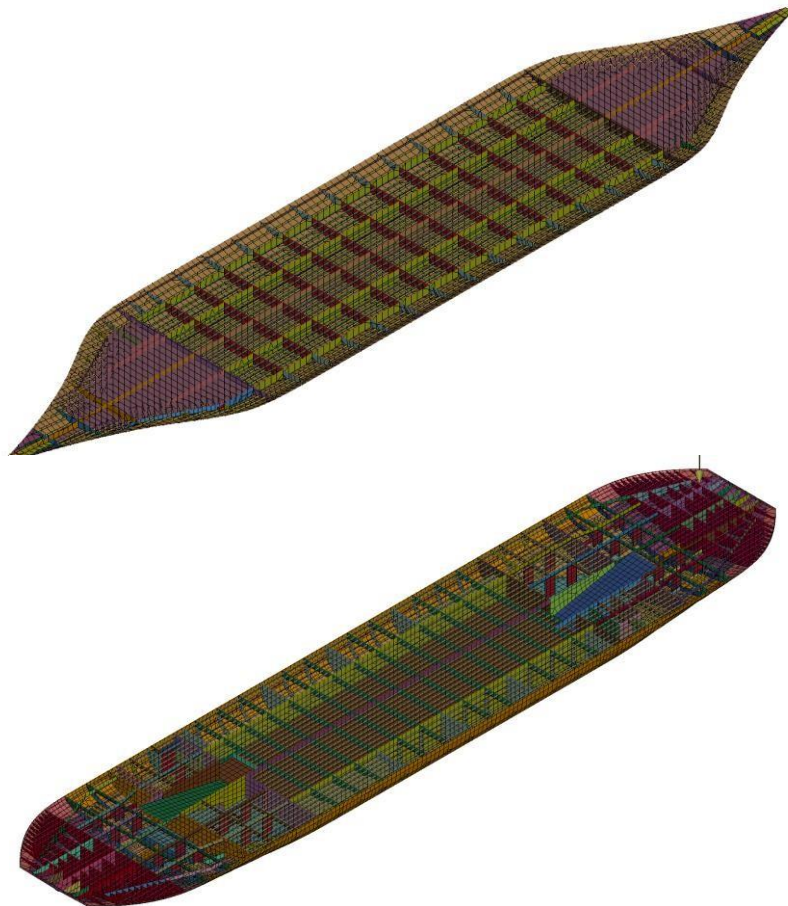


### 3.3. FE Modelling Characteristics

For all three models mesh was created of the shell elements with the usage of the “Fully integrated shell element” formulation option. In creating mesh two elements types were used which are quadrilateral and triangular element. Initial dimension of the mesh element is 600 mm, where that was necessary elements were smaller in order to better define geometry and to sustain mesh quality in problematic places.

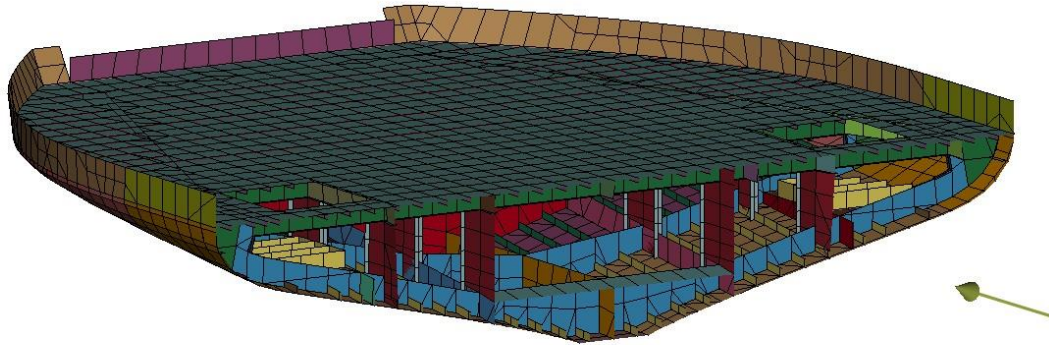
*Table 12 Number of elements for each model and their shape (formulation)*

	<b>Model 1</b>	<b>Model 2</b>	<b>Model 3</b>
<b>No. of elements</b>	44126	64984	79932
<b>Quads</b>	39225	58142	71790
<b>Trias</b>	4901	6842	8142

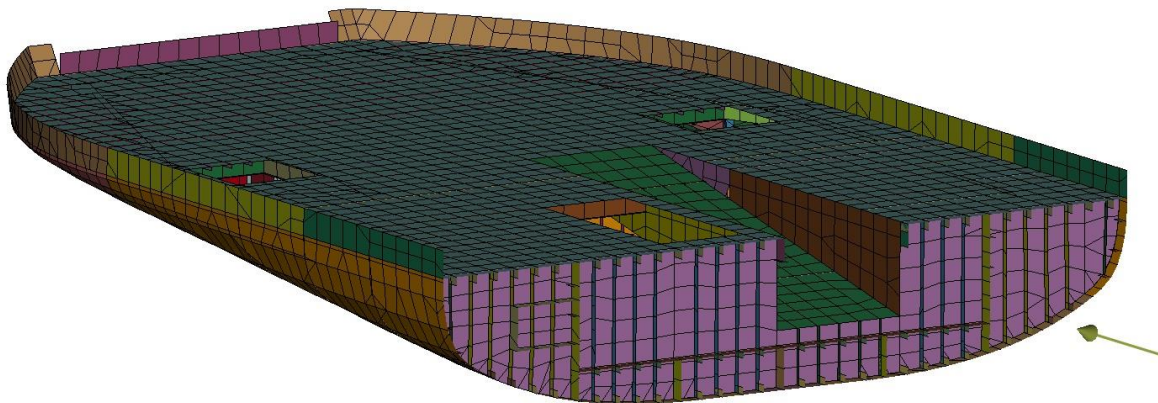


**Figure 19** Mesh representation on structure bellow main deck





**Figure 20** Mesh representation on structure below main deck, ship end



**Figure 21** Mesh representation on structure below main deck, watertight bulkhead

Base units that are used in the simulations are:

- Length: millimeters, mm
- Forces: Newton, N
- Stresses: mega Pascal, MPa

### 3.4. Calculation Data and Assumption

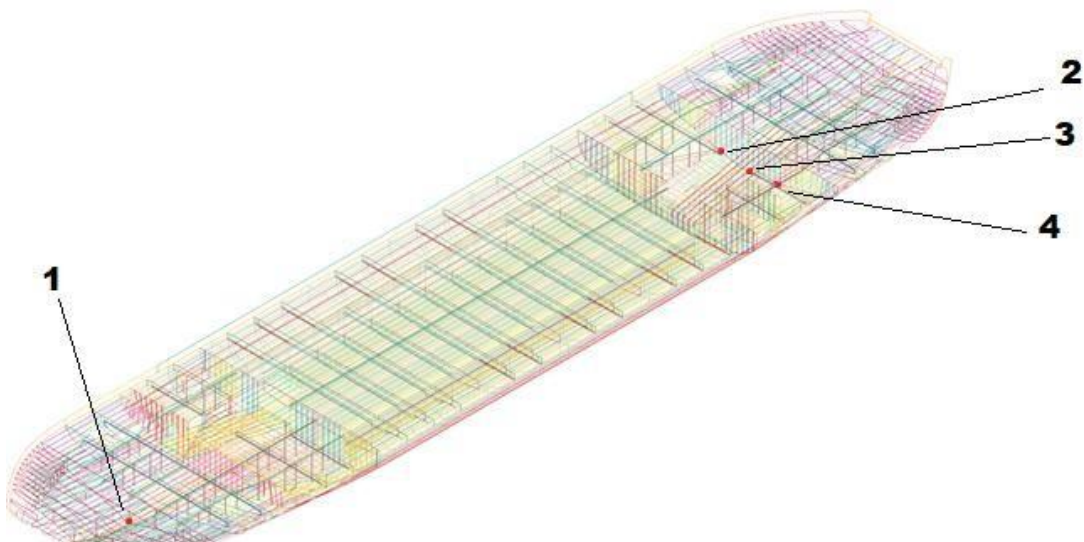
#### 3.4.1. Boundary condition

In order to prevent rigid body motions of the overall model, the constraints specified below are applied on all the models in all simulations, Table 13, Figure 22.

The model itself needs to be in quasi-static equilibrium so that the reactions in the nodes that we prevented the displacement / rotation are minimal. A total unbalanced force below 2% of the displacement is considered acceptable according to BV [11]. The model balancing procedure changes two parameters, ship draft and trim angle, in the case of a symmetrical load case. For the asymmetric case, an additional parameter is introduced - the angle of the transverse tilt of the ship. By varying the above parameters in an iterative procedure (which is usually a preparation for FEM calculation), [14], the conditions of buoyancy and minimum reactions at the ends are met.

**Table 13** *Boundary conditions imposed on the model*

Boundary conditions	Degree of freedom (DOF)		
	X	Y	Z
Fore node in CL, 1	fixed	fixed	fixed
Aft node in CL, 2	free	fixed	free
One node on the starboard side at the aft end, 3	free	free	fixed
One node on the portside side at the aft end, 4	free	free	fixed



**Figure 22** *Boundary conditions positions*

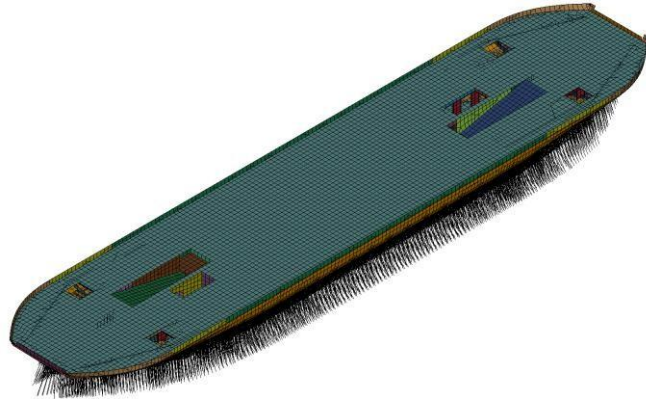
### 3.4.2. Loading conditions

Three different loading conditions are used in the simulations. Loading conditions are separated into the load cases LC1, LC2, LC3. Load case one (LC1) has got only hydrostatic load, Figure 23, while LC2, and LC3 have in themselves hydrostatic load and cargo load (cars and trucks). LC2 has hydrostatic load and cars on the Main deck and Tank top, Figure 24, while LC3 has hydrostatic load and trucks on the Main deck while there are cars on the Tank top, Table 14, Figure 25.

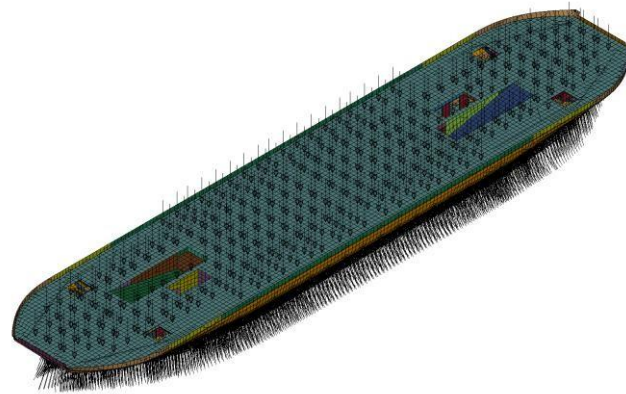
**Table 14** Schematic representation of load conditions

Load case		Displacement, t	Draught, m	Cars	Trucks
LC1	Trim&Stability Book	1804	1.851	-	-
	FEM*	1790	1.849	-	-
LC2	Trim&Stability Book	2782	2.473	Yes	-
	FEM*	2699	2.459	Yes	-
LC3	Trim&Stability Book	2446	2.287	Yes	Yes
	FEM*	2345	2.276	Yes	Yes

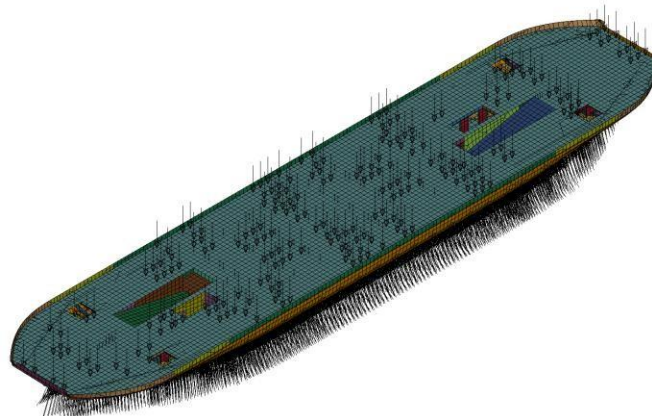
*Weights, t	LC1	LC2	LC3
FEM structure + main equipment	1405	1405	1405
Cargo equipment	83	83	83
Ship equipment	37	37	37
Crew and Passengers equipment	173	173	173
Ship systems	92	92	92
Bunkers	-	99	92
Ballast waters	-		63
Deadweight	-	810	400
Total:	1790	2699	2345



**Figure 23** Load case 1. (LC1) implemented in Model 1



**Figure 24** Load case 2. (LC2), implemented in Model 2



**Figure 25** Load case 3. (LC3), implemented in Model 3

### 3.4.3. Calculation assumptions

All simulations are performed with the following assumptions:

- Static analysis
- Small displacement
- Linear behaviour of materials

### 3.5. Results

The analysis of the results is carried out for all three models and for each of this model all three loading conditions are analysed.

**Table 15** *Loading conditions imposed on the model*

		Models		
		Model 1	Model 2	Model 3
Loading cases	LC 1	Simulation 1.1.	Simulation 2.1.	Simulation 3.1.
	LC 2	Simulation 1.2.	Simulation 2.2.	Simulation 3.2.
	LC 3	Simulation 1.3.	Simulation 3.3.	Simulation 3.3.

Results are presented globally for the whole model, and locally for some parts of the structure.



### 3.5.1. Simulation 1.1.

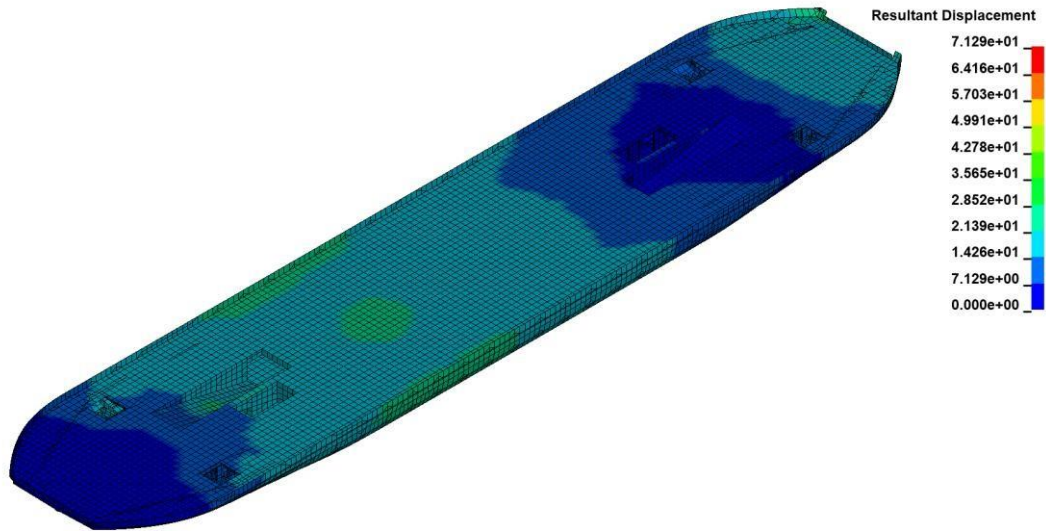


Figure 26 Global isometric view of resultant displacement

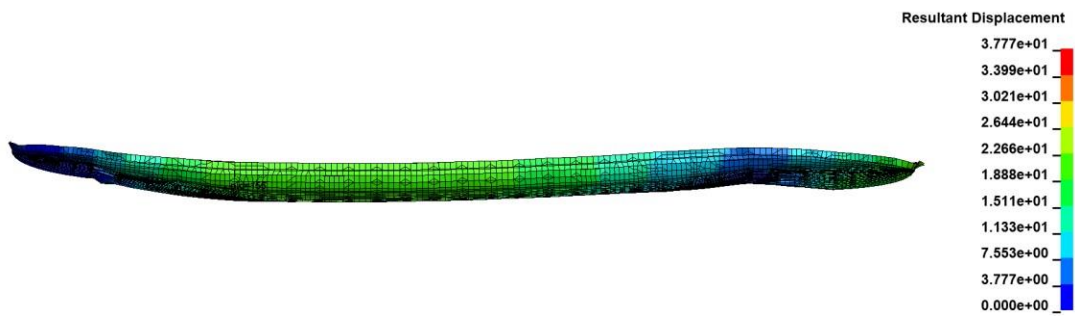
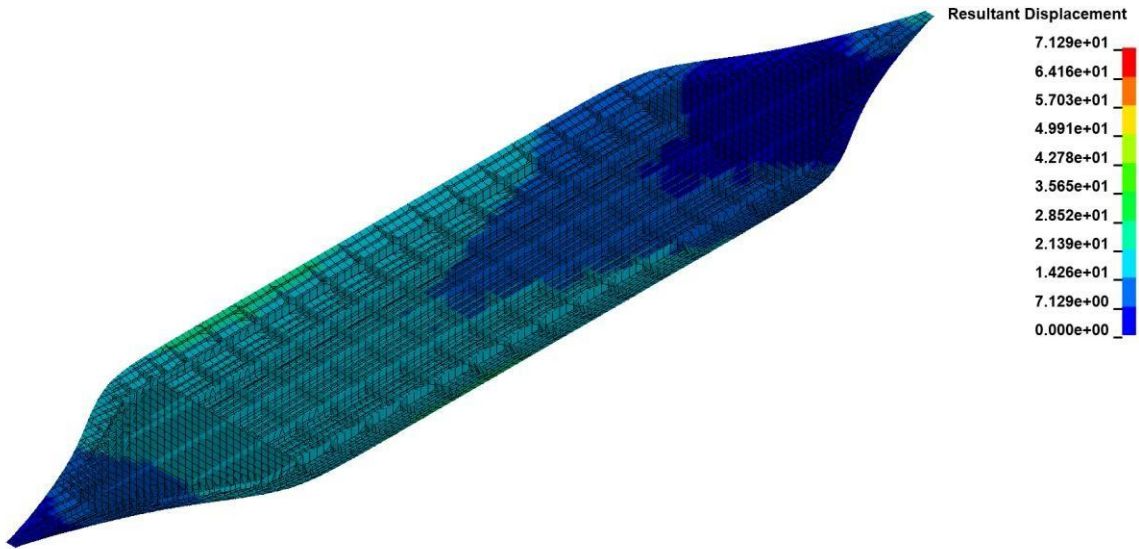


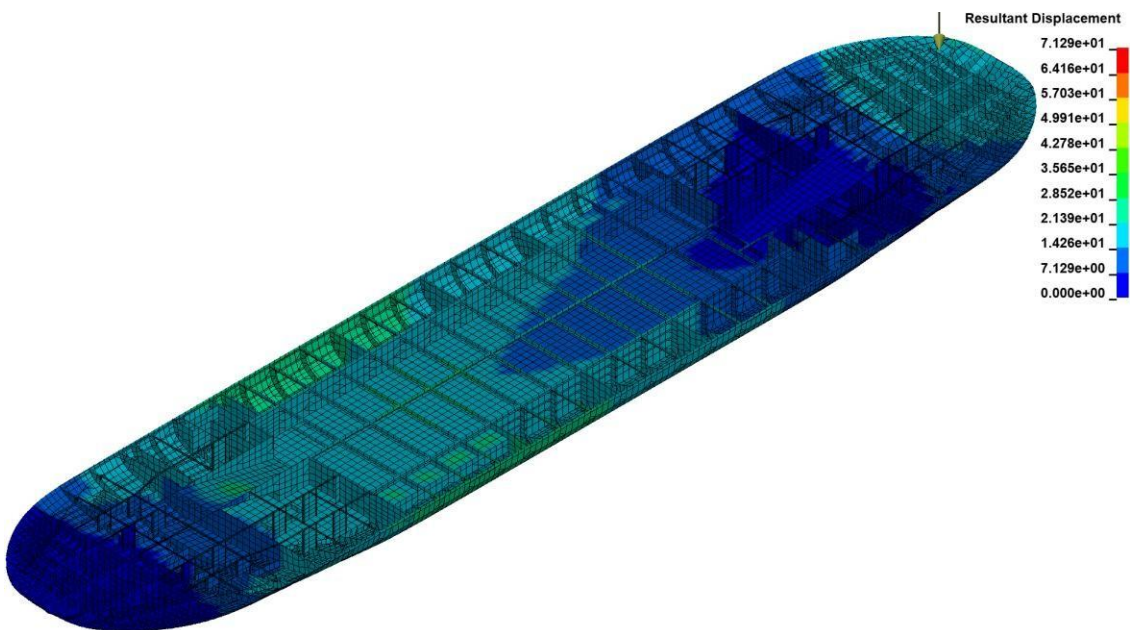
Figure 27 Global side view of resultant displacement scaled by 50



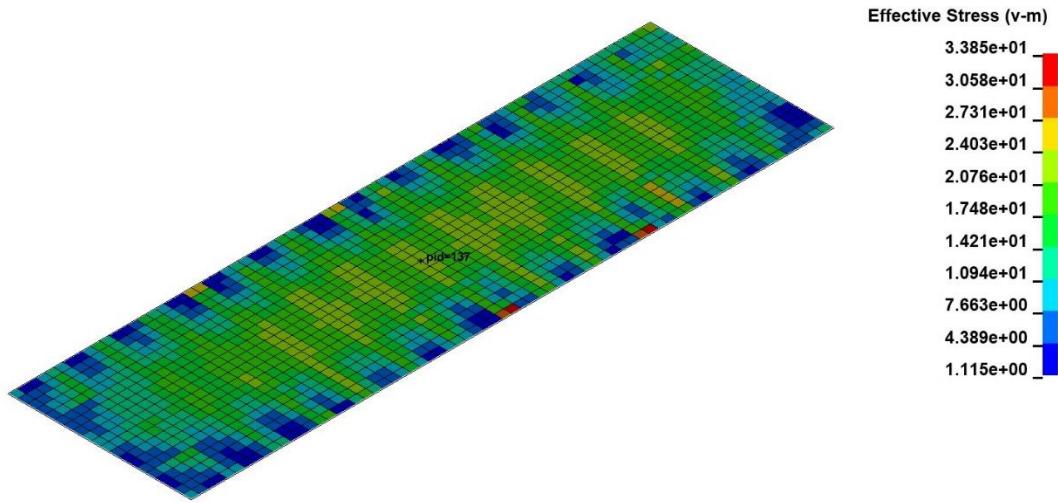
Figure 28 Global side view of resultant displacement scaled by 100



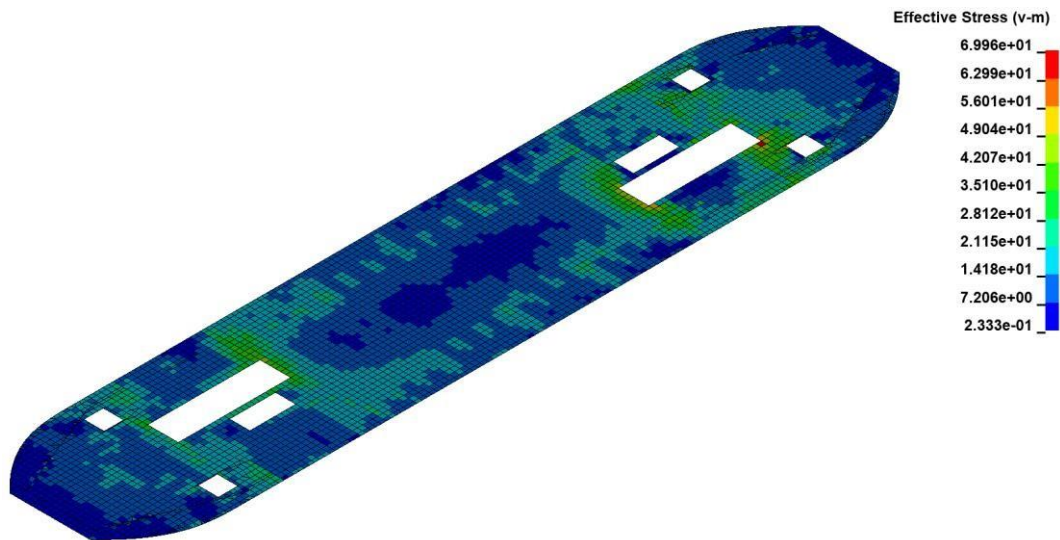
**Figure 29** *Global isometric view of resultant displacement up to the Tank top*



**Figure 30** *Global isometric view of resultant displacement up to the Main deck*

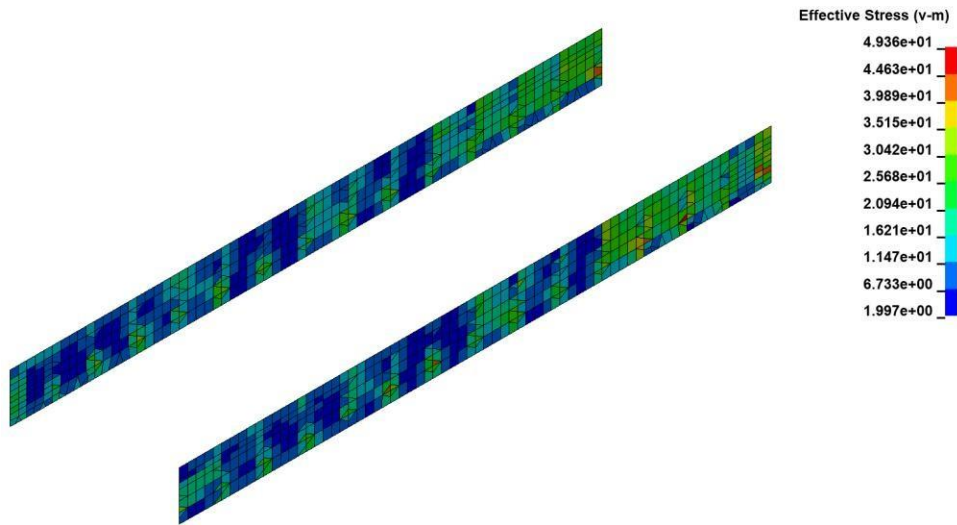


**Figure 31** Von Mises stress for Tank top

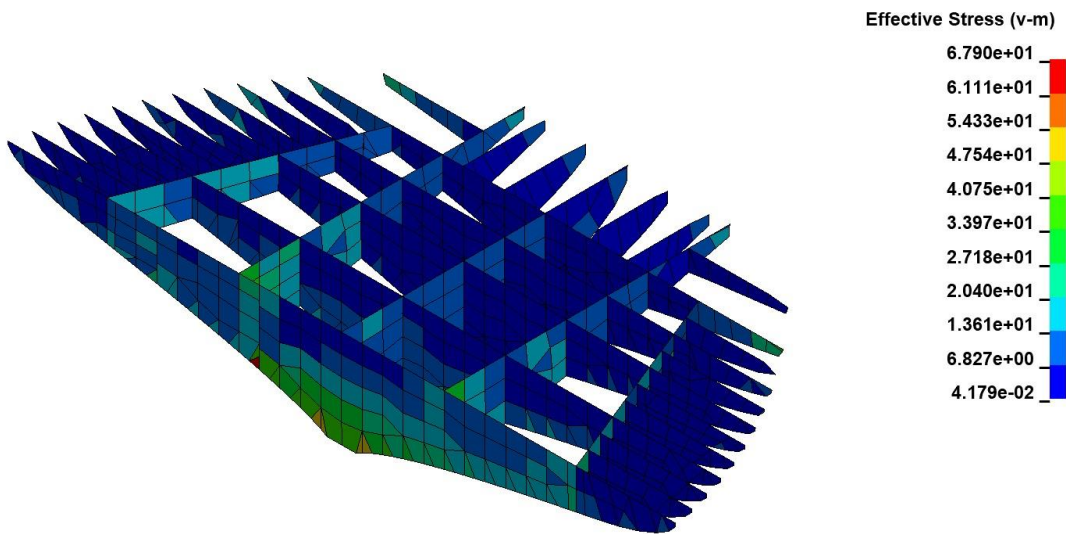


**Figure 32** Von Mises stress for Main deck

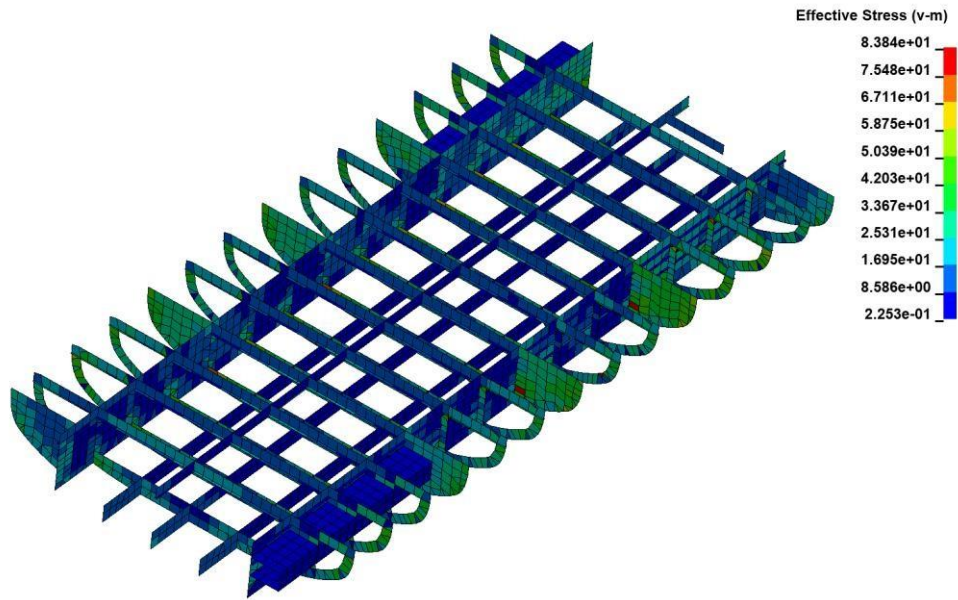




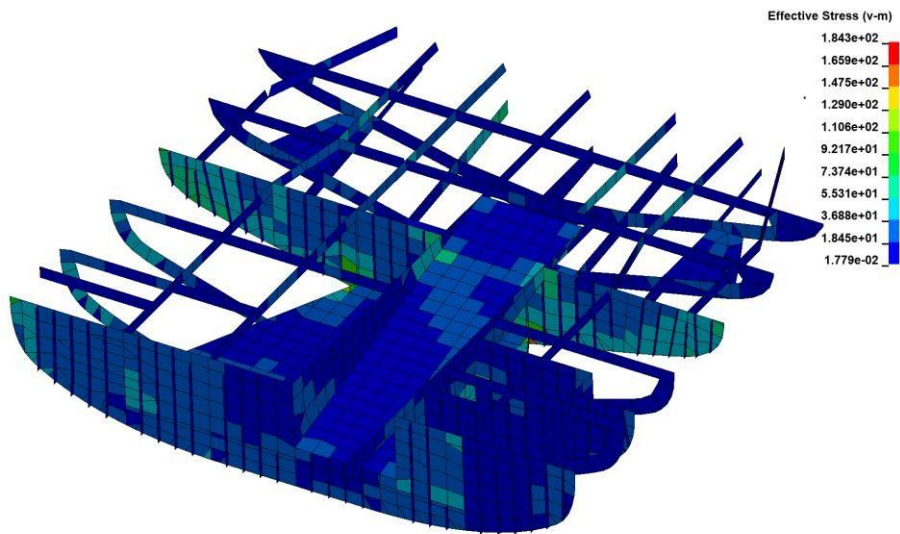
**Figure 33** Longitudinal bulkhead below Main deck on  $y= +/-5800$



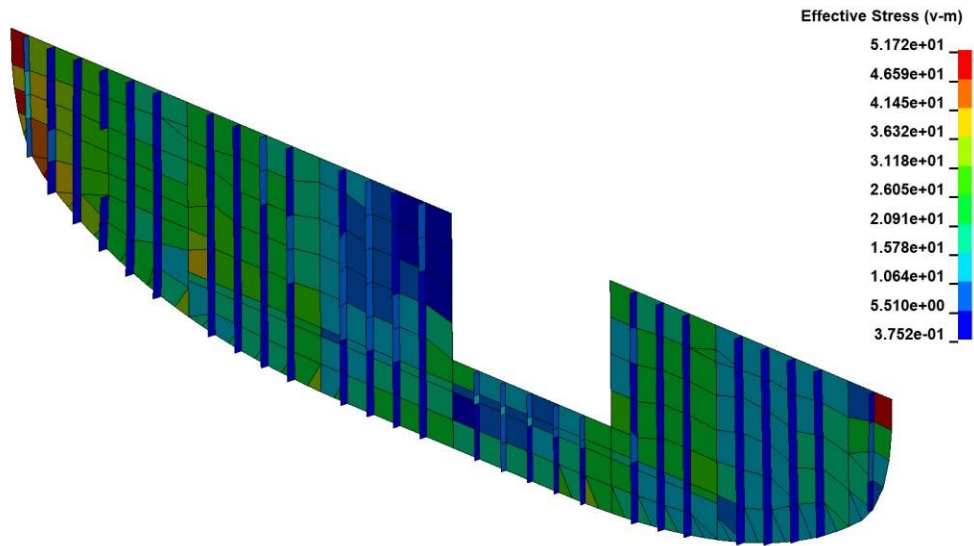
**Figure 34** Von Mises stress for structure below Main deck and between Fr50 and aft end (without stiffeners)



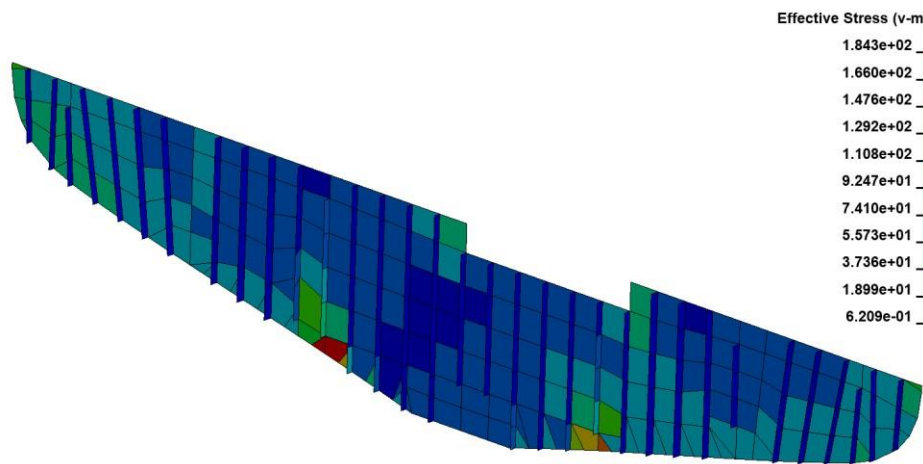
**Figure 35** Von Mises stress for structure between Fr35 – Fr-35 and below Tank top



**Figure 36** Von Mises stress for structure below Main deck and between Fr35 and aft end

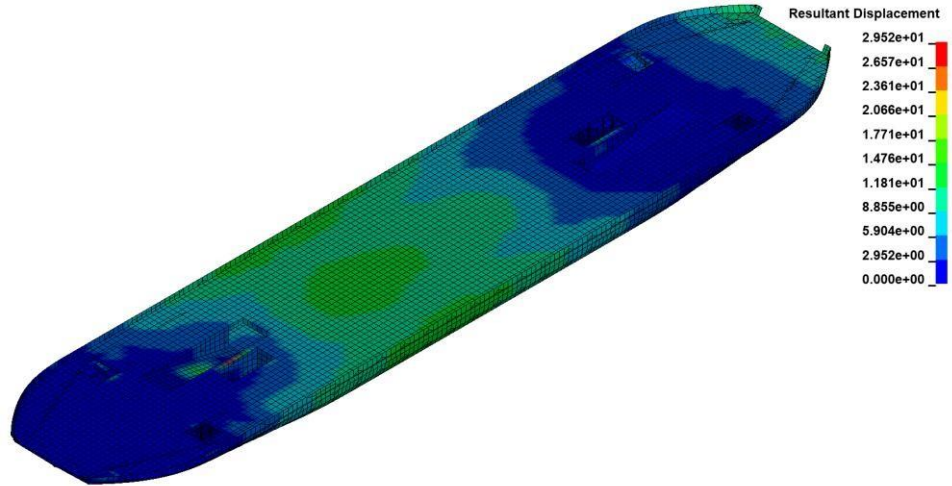


**Figure 37** Von Mises stress for transverse bulkhead on the Fr35

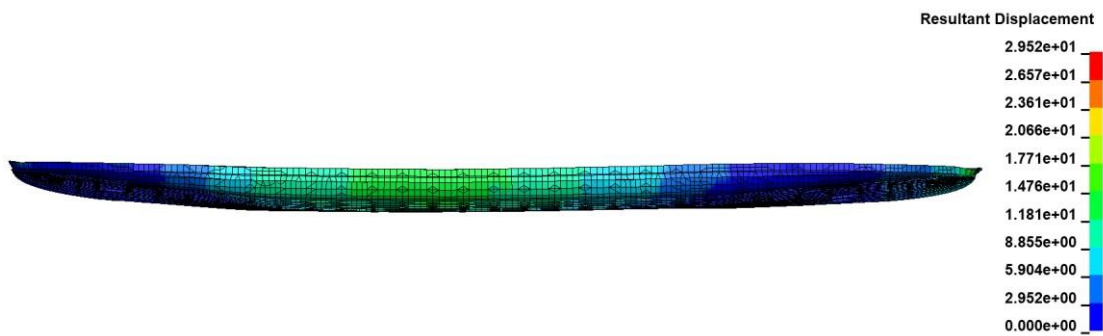


**Figure 38** Von Mises stress for transverse bulkhead on the Fr50

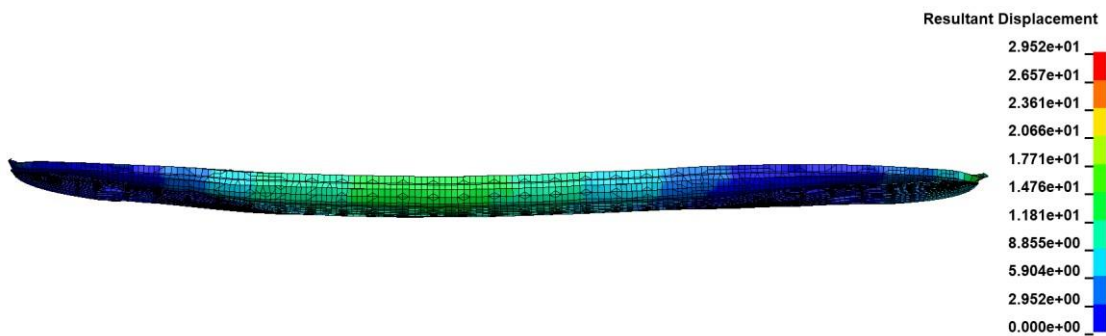
### 3.5.2. Simulation 1.2.



**Figure 39** *Global isometric view of resultant displacement*



**Figure 40** *Global side view of resultant displacement scaled by 50*



**Figure 41** *Side view of resultant displacement scaled by 100*



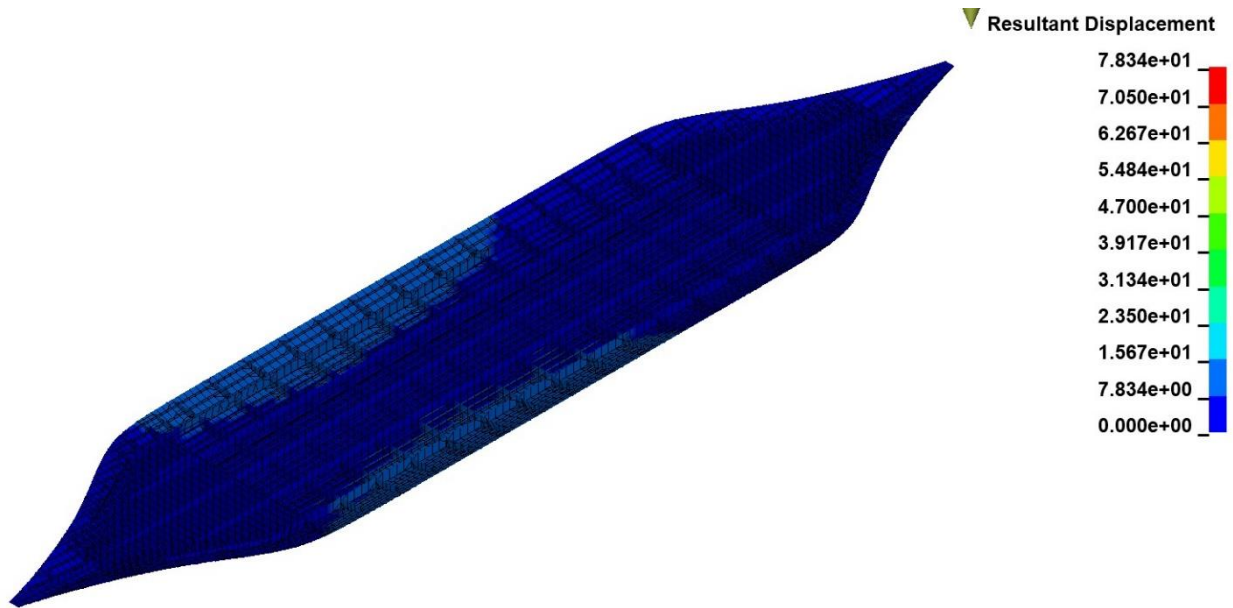


Figure 42 Global isometric section view of resultant displacement up to the Tank top

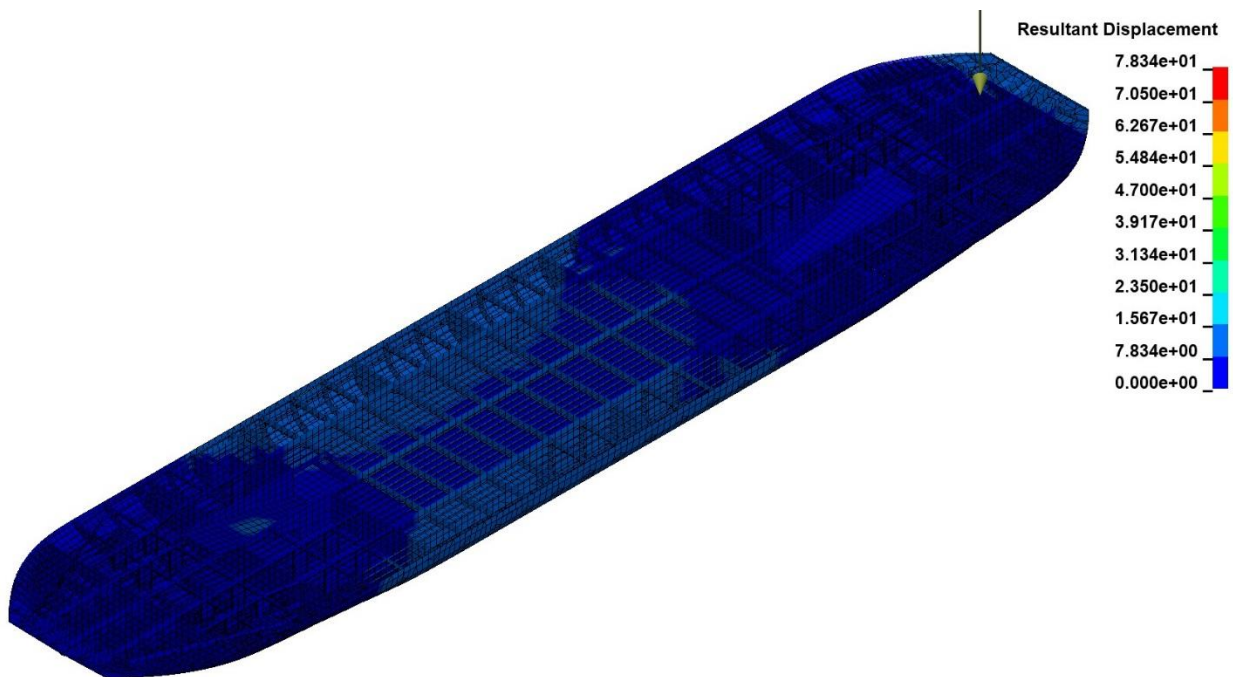
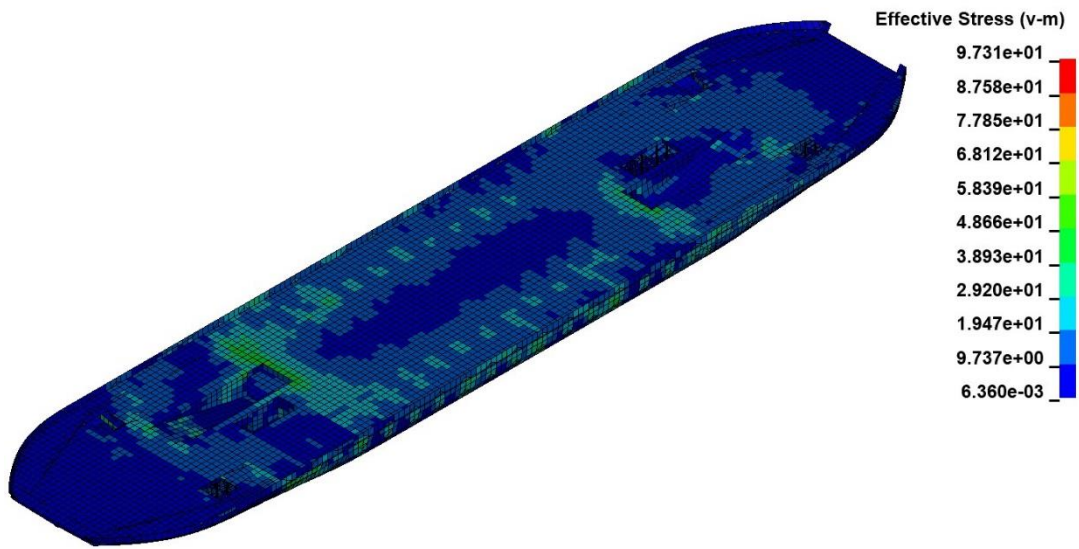
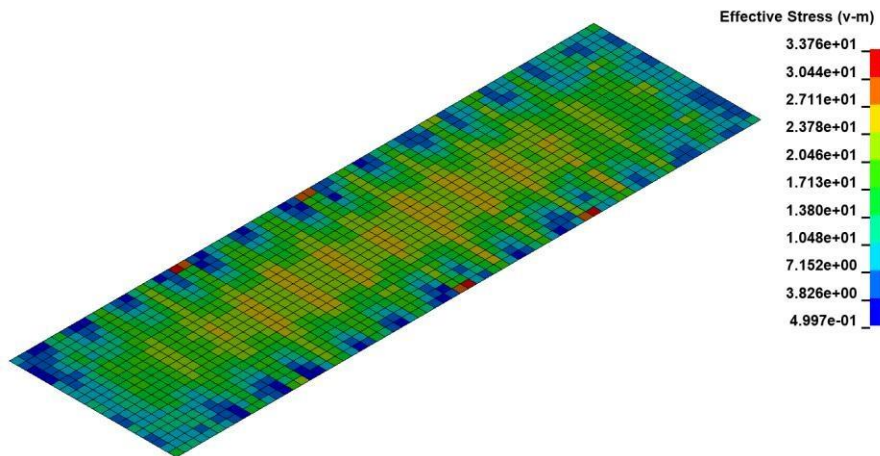


Figure 43 Global isometric section view of resultant displacement up to the Main deck

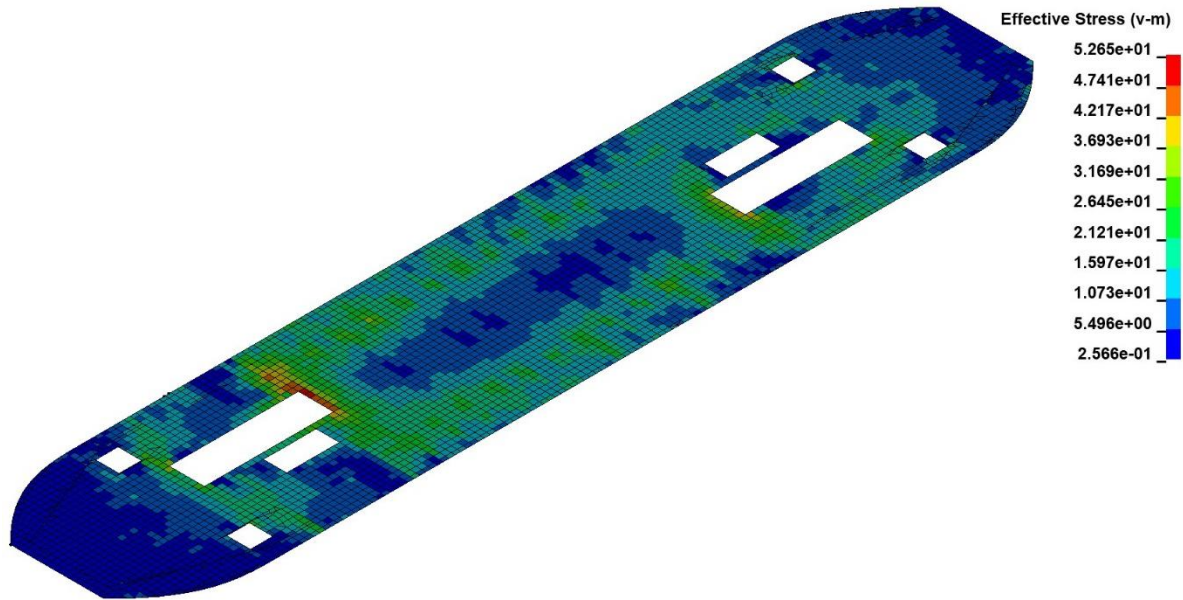


**Figure 44** Von Mises stress for global model

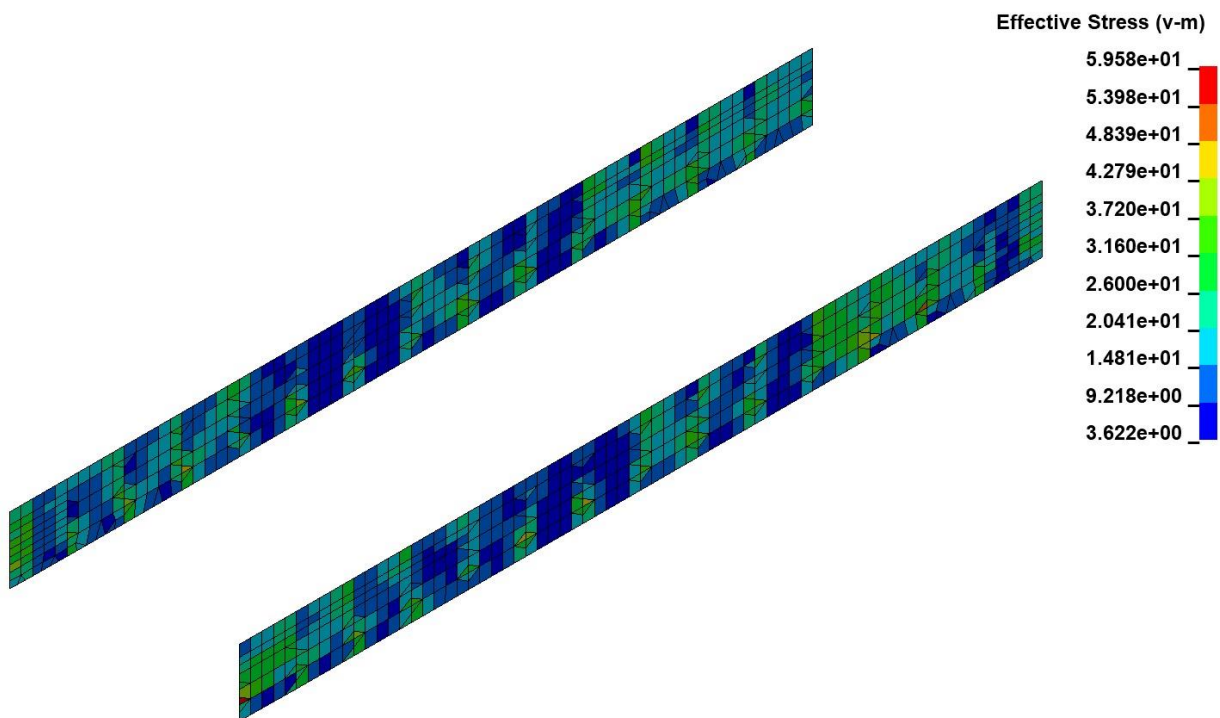


**Figure 45** Von Mises stress Tank top

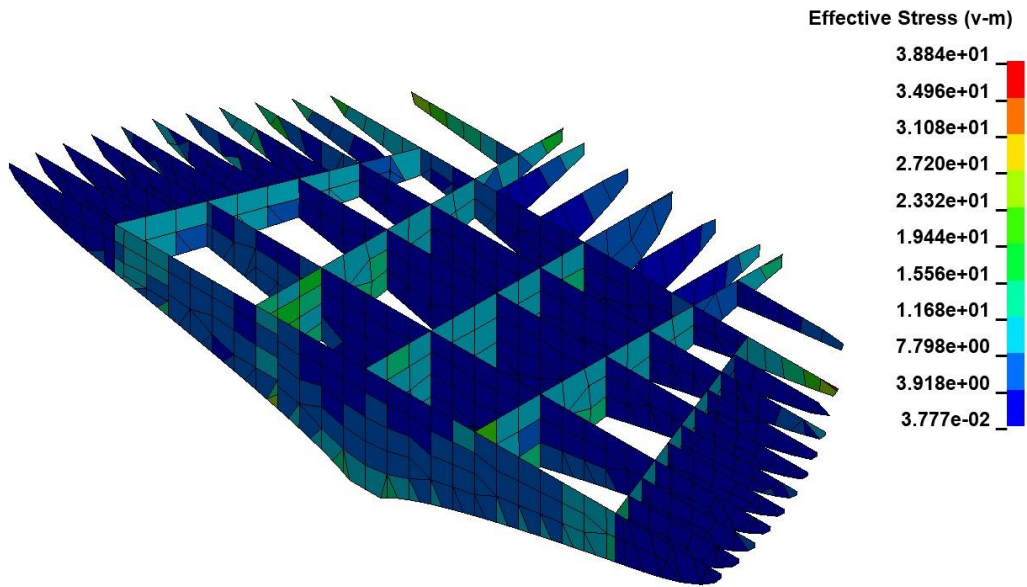




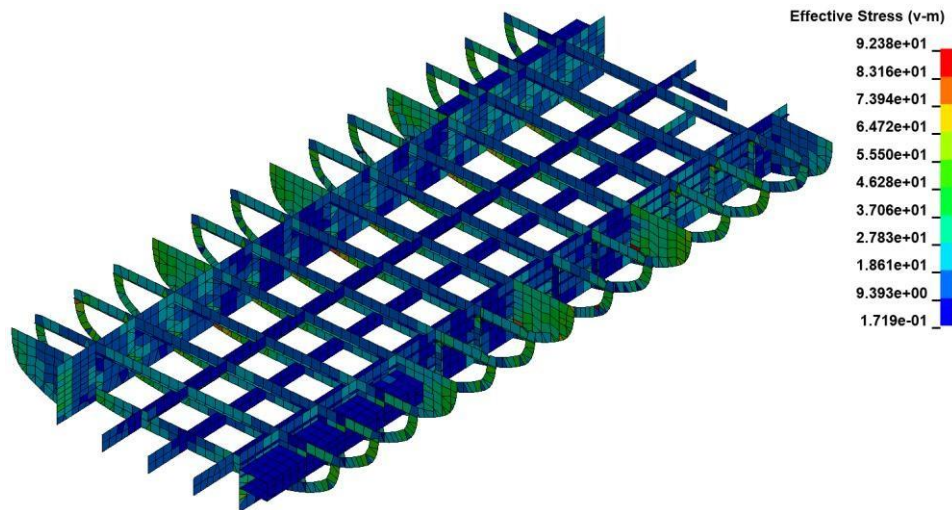
**Figure 46** Von Mises stress for Main deck



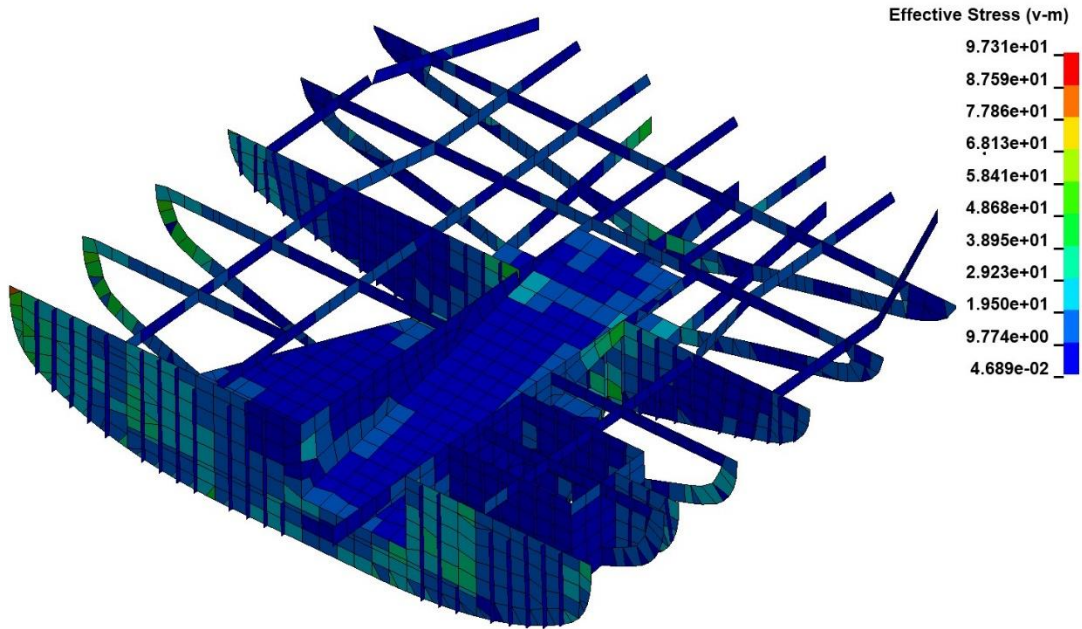
**Figure 47** Longitudinal bulkhead below Main deck on  $y = \pm 5800$



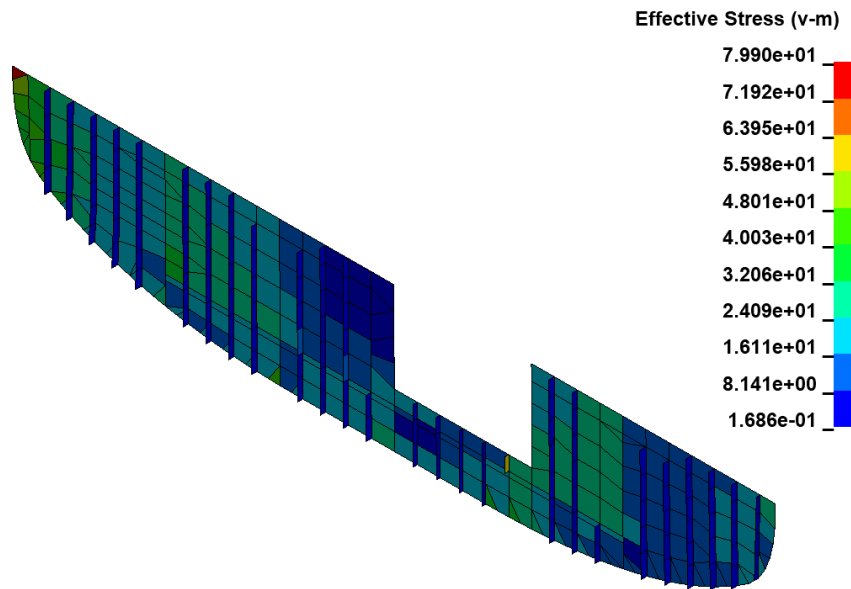
**Figure 48** Von Mises stress for structure below Main deck and between Fr50 and aft end (without stiffeners)



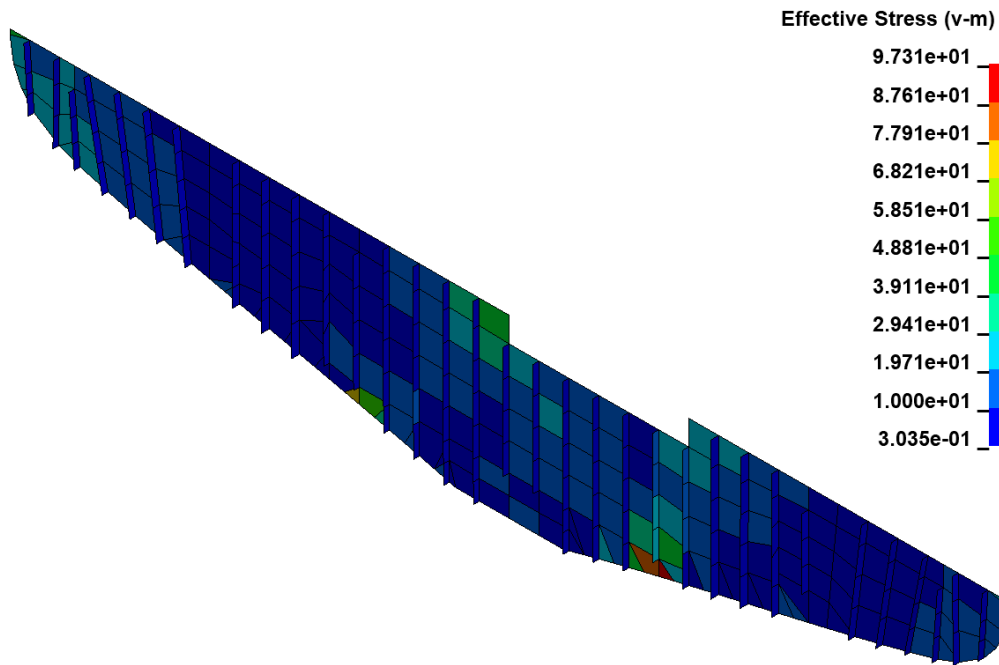
**Figure 49** Von Mises stress for structure between Fr35 – Fr-35 and below Tank top



**Figure 50** Von Mises stress for structure below Main deck and between Fr35 and aft end



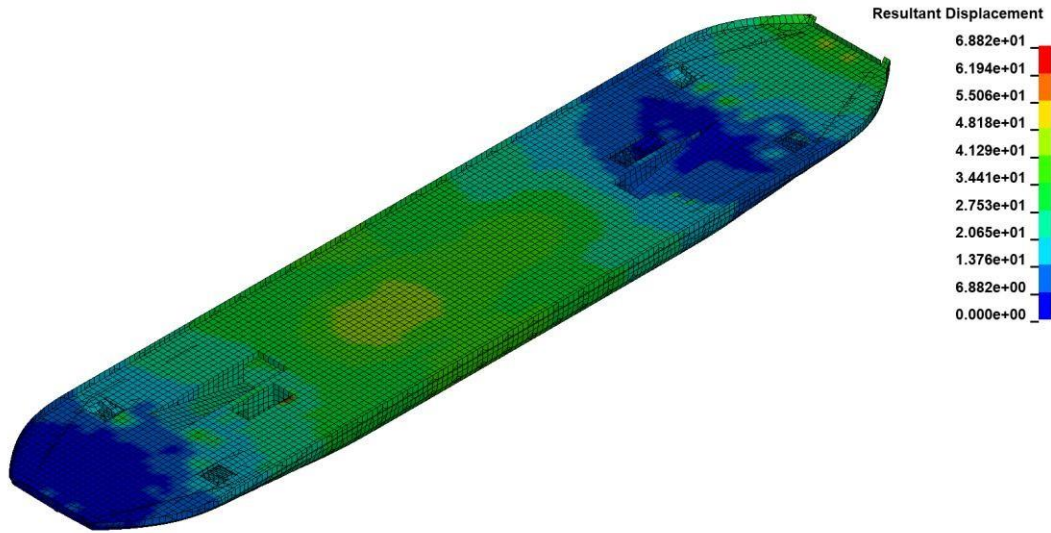
**Figure 51** Von Mises stress for transverse bulkhead on the Fr35



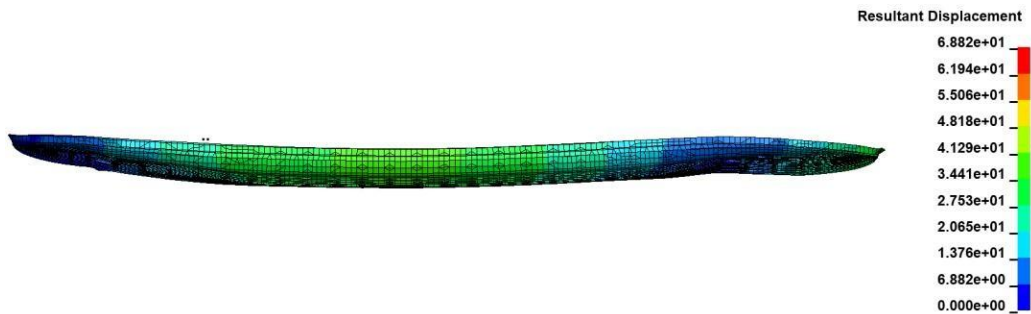
**Figure 52** Von Mises stress for transverse bulkhead on the Fr50



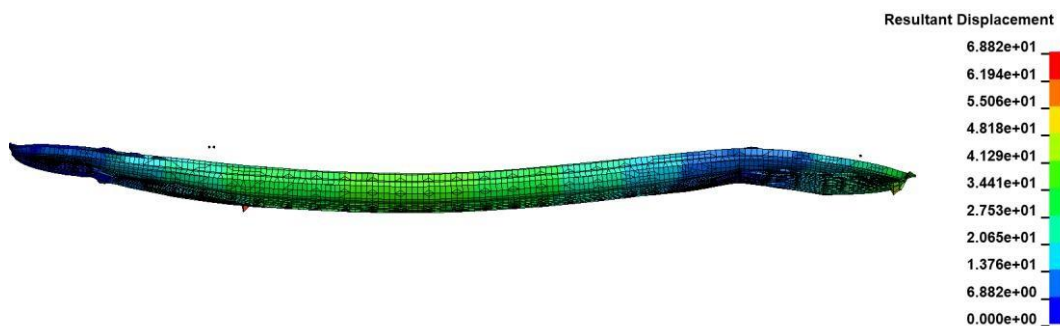
### 3.5.3. Simulation 1.3.



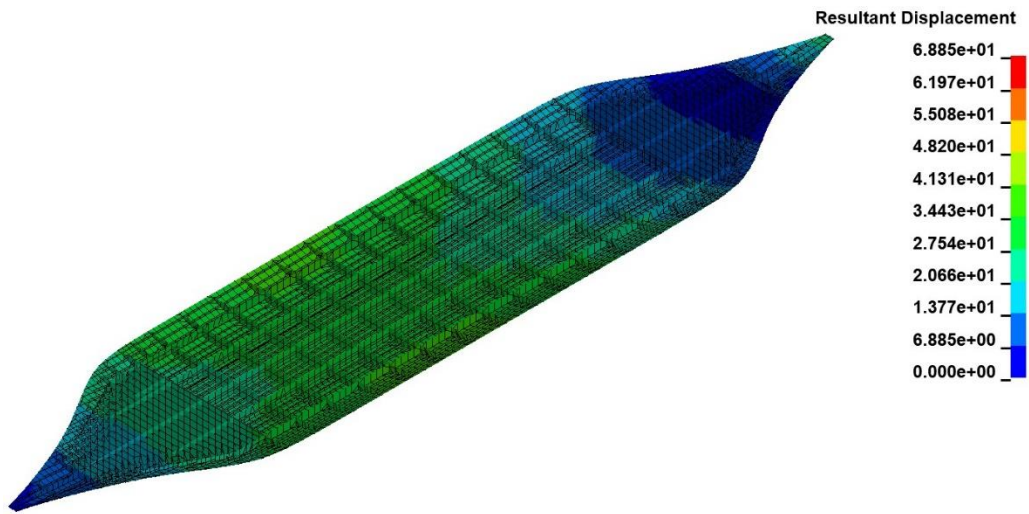
**Figure 53** *Global isometric view of resultant displacement*



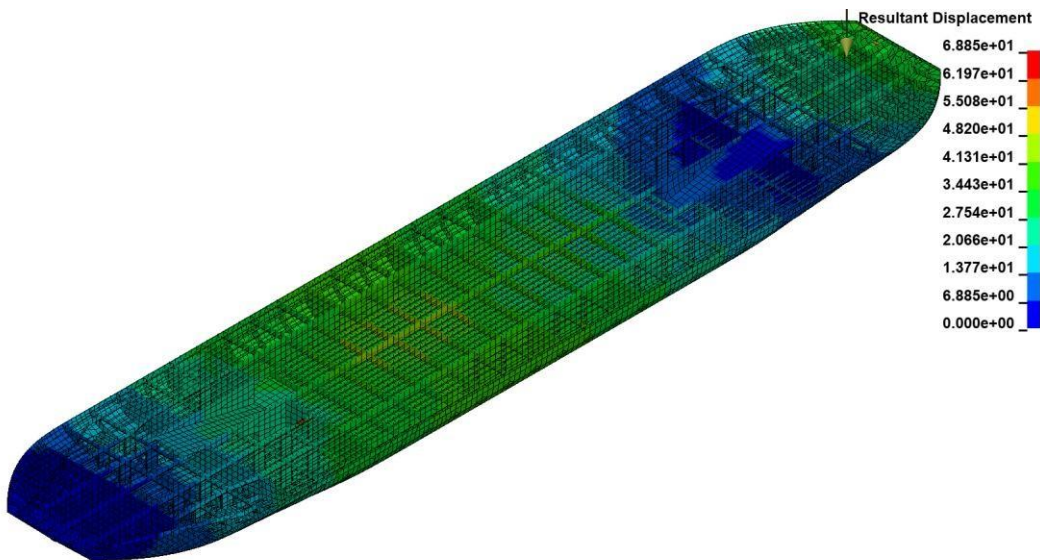
**Figure 54** *Global side view of resultant displacement scaled by 50*



**Figure 55** *Global side view of resultant displacement scaled by 100*

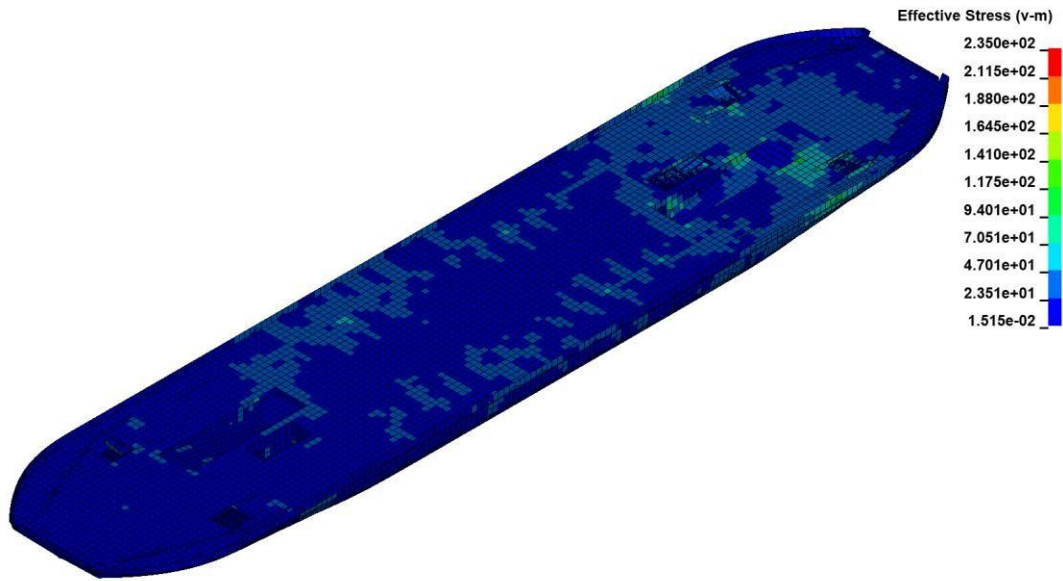


**Figure 56** *Global isometric section view of resultant displacement up to the Tank top*

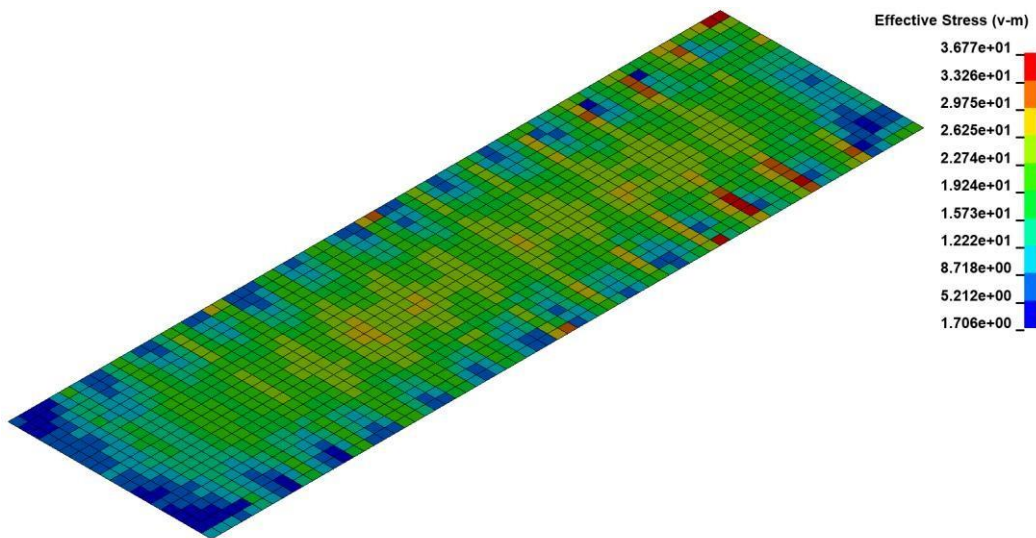


**Figure 57** *Global isometric section view of resultant displacement up to the Main deck*

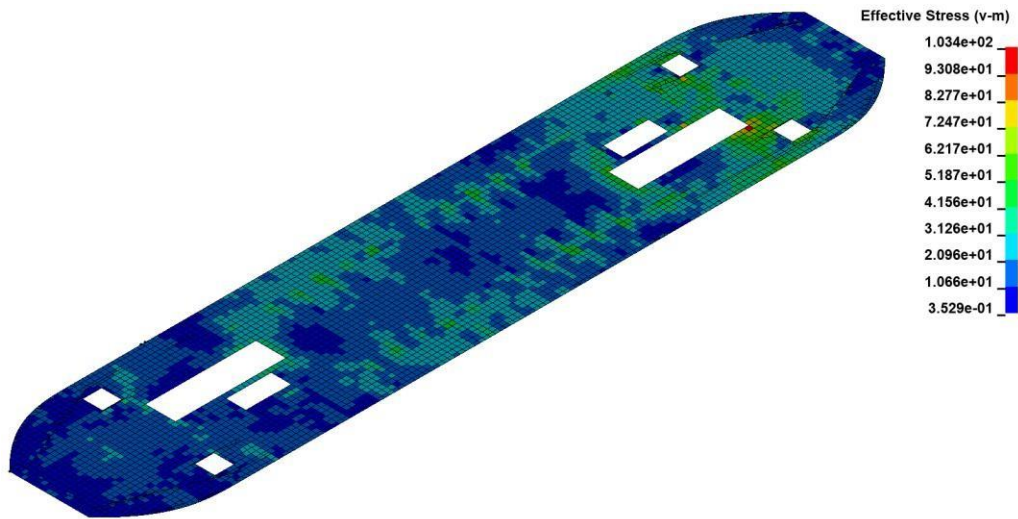




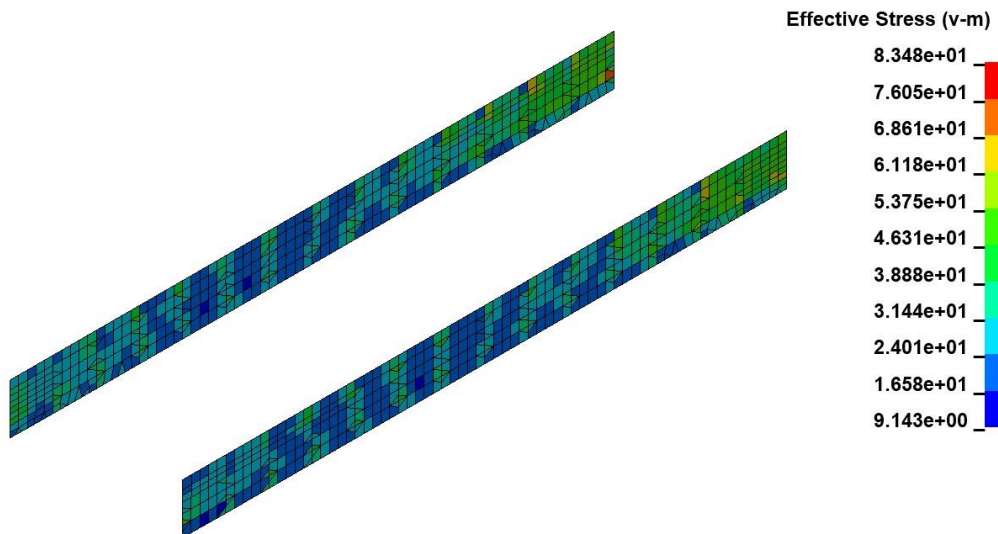
**Figure 58** *Von Mises stress for global model*



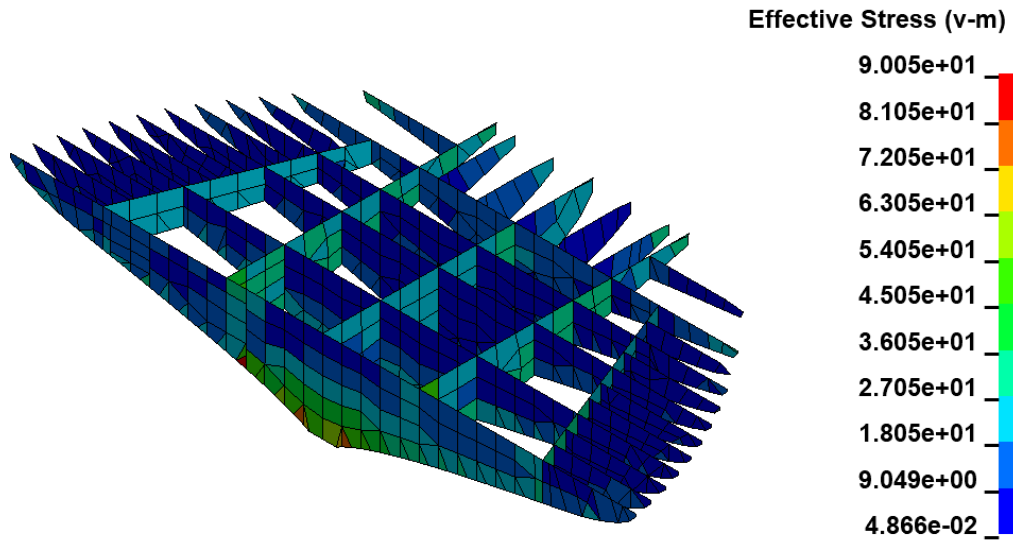
**Figure 59** *Von Mises stress for Tank top*



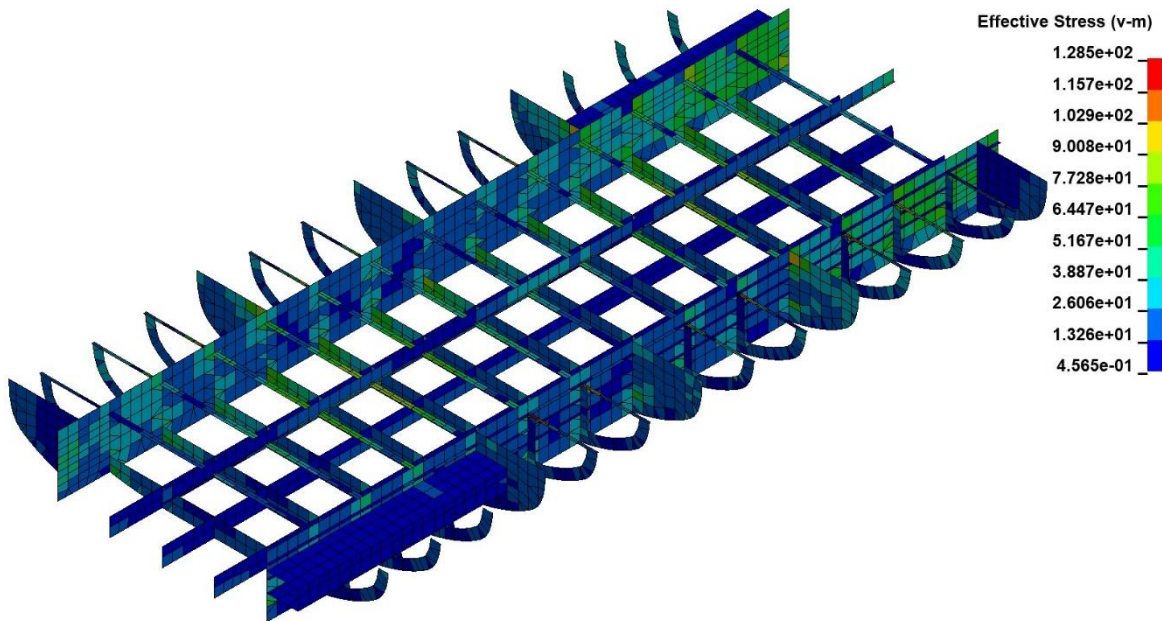
**Figure 60** Von Mises stress for Main deck



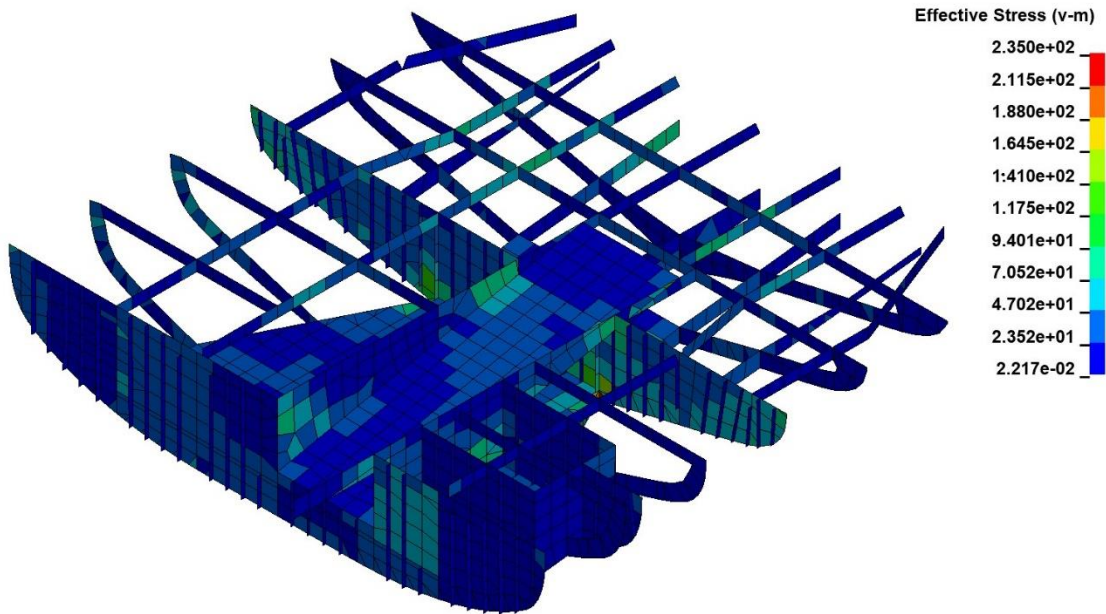
**Figure 61** Longitudinal bulkhead below Main deck on  $y = \pm 5800$



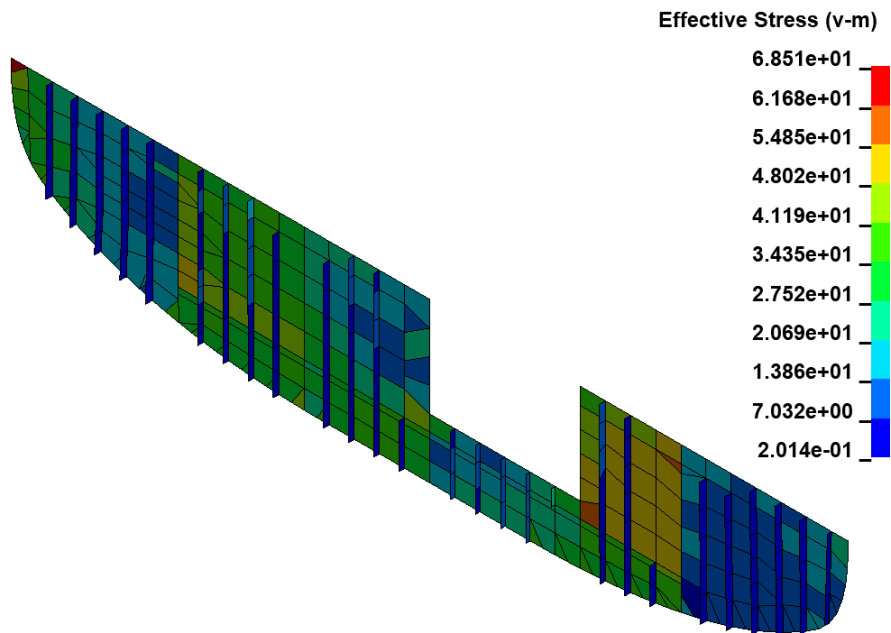
**Figure 62** Von Mises stress for structure below Main deck and between Fr50 and aft end (without stiffeners)



**Figure 63** Von Mises stress for structure between Fr35 – Fr-35 and below Tank top

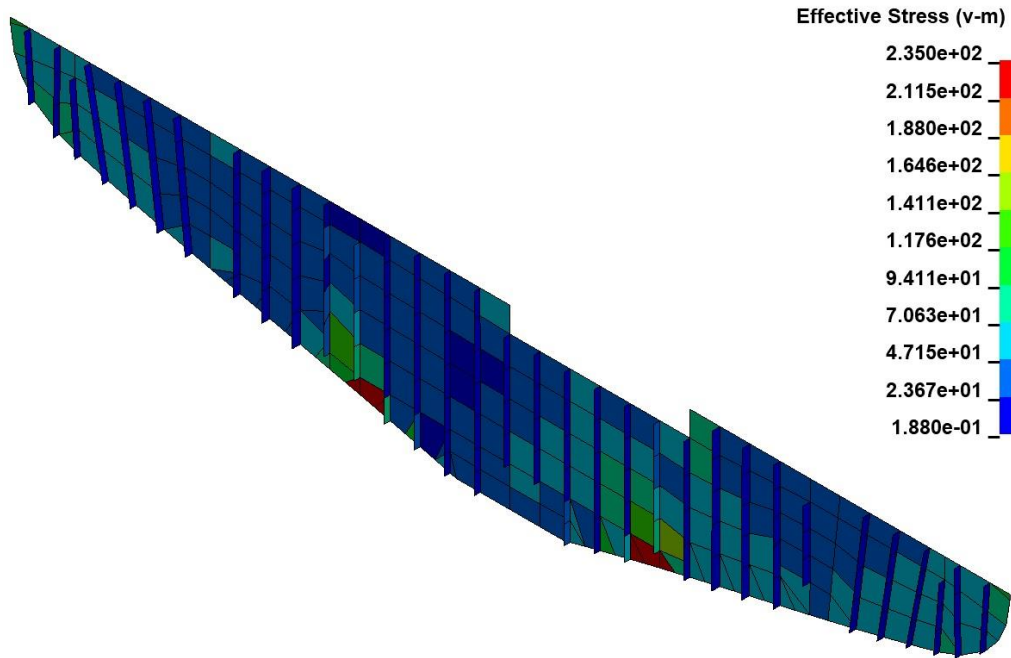


**Figure 64** Von Mises stress for structure below Main deck and between Fr35 and aft end



**Figure 65** Von Mises stress for transverse bulkhead on the Fr35

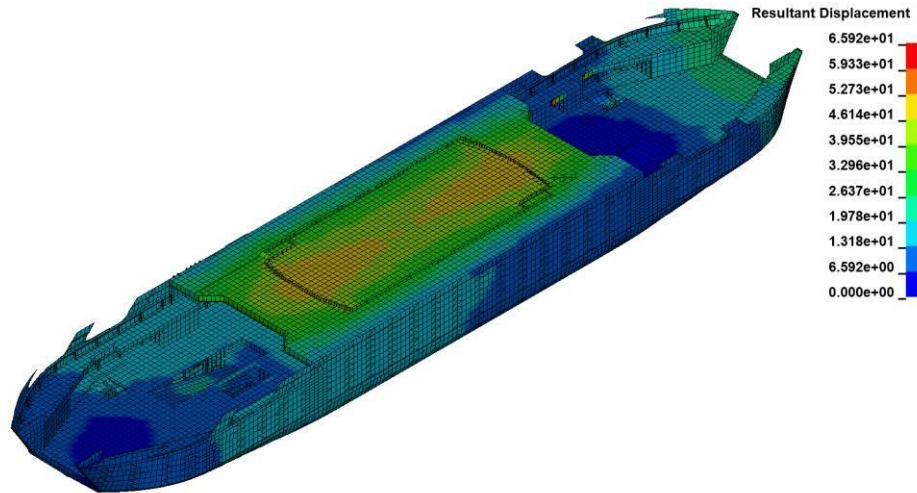




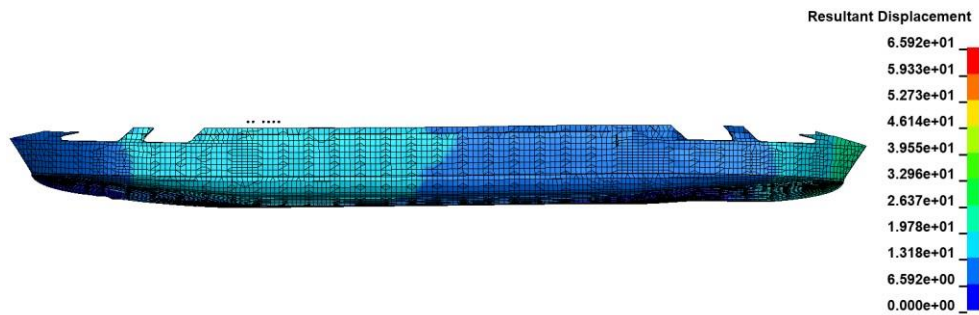
**Figure 66** Von Mises stress for transverse bulkhead on the Fr50



### 3.5.4. Simulation 2.1.



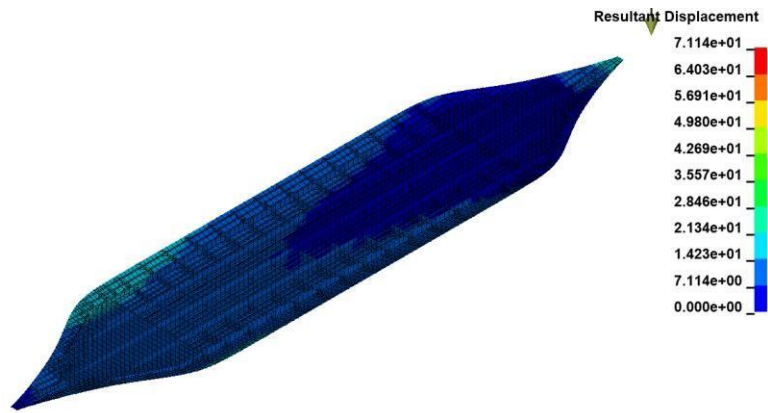
**Figure 67** Global isometric view of resultant displacement



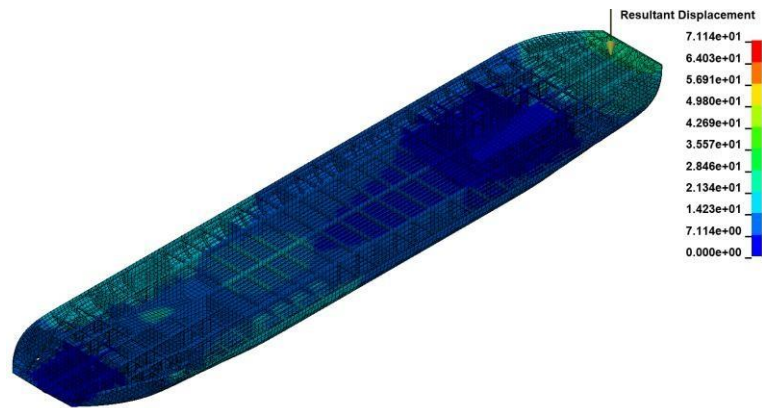
**Figure 68** Global isometric side view of resultant displacement scaled by 50



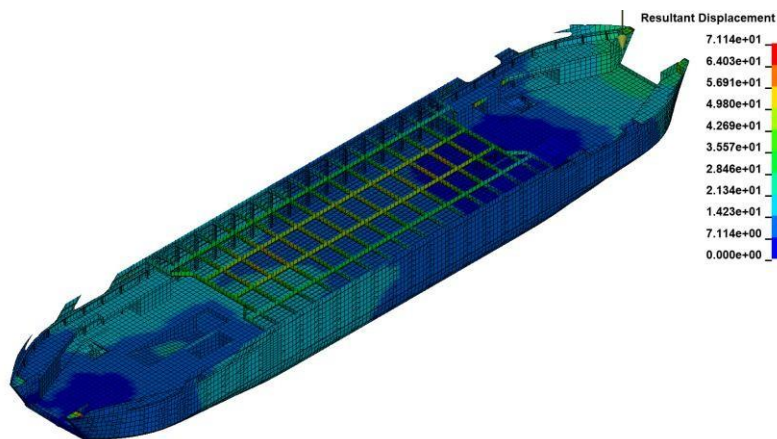
**Figure 69** Global isometric side view of resultant displacement scaled by 100



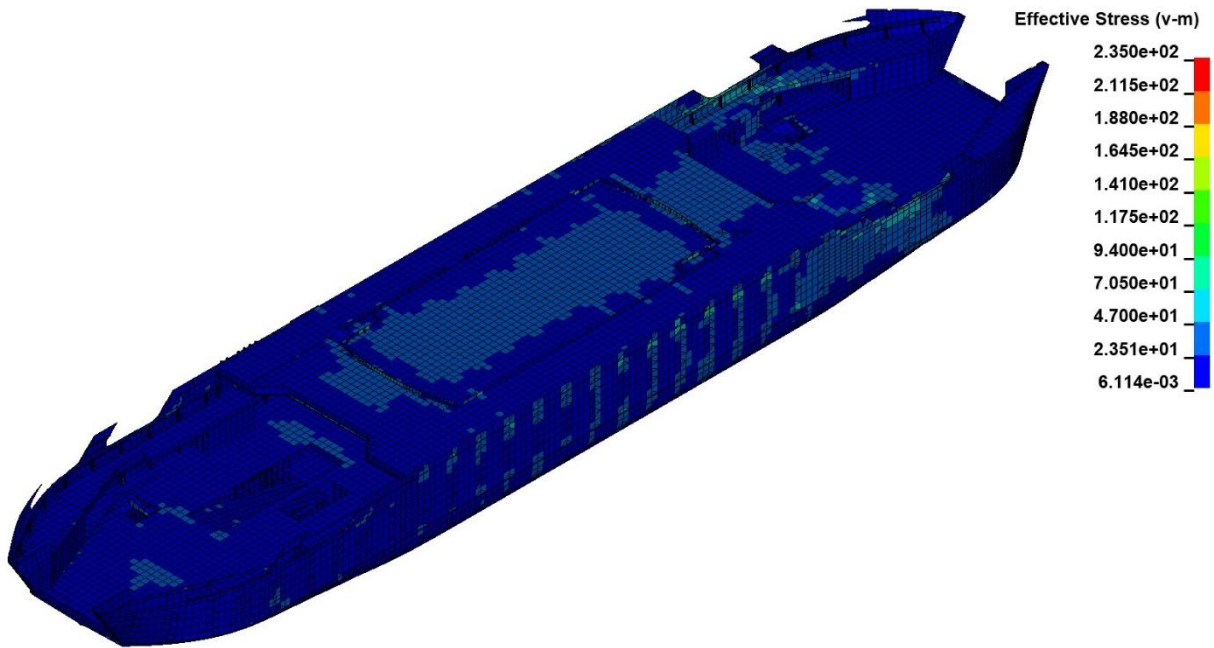
**Figure 70** Global isometric section view of resultant displacement up to the Tank top



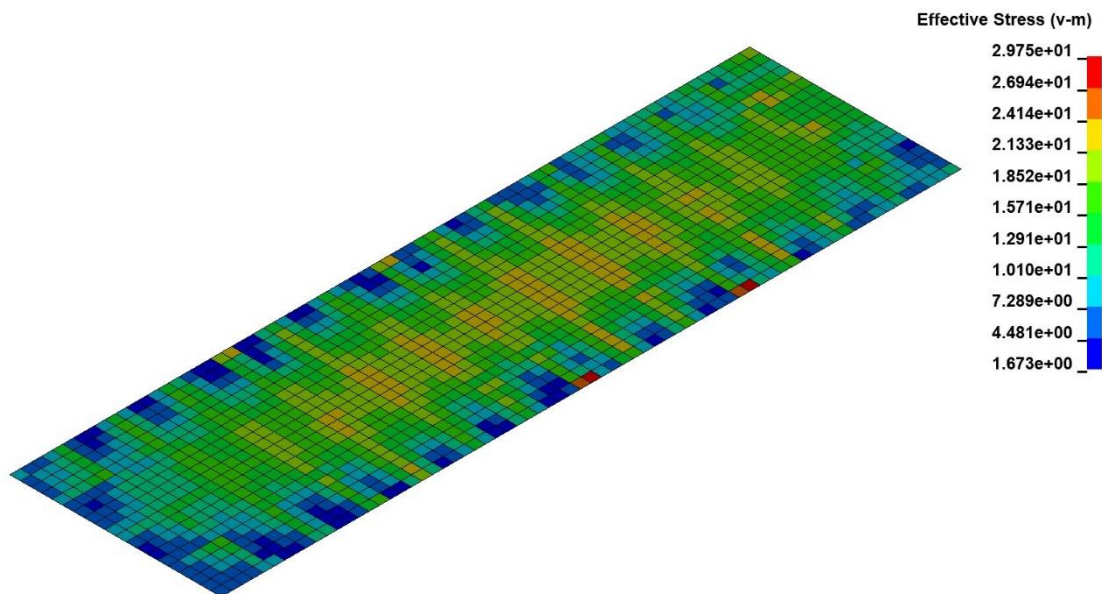
**Figure 71** Global isometric section view of resultant displacement up to the Main deck



**Figure 72** Global isometric section view of resultant displacement up to the Passenger deck

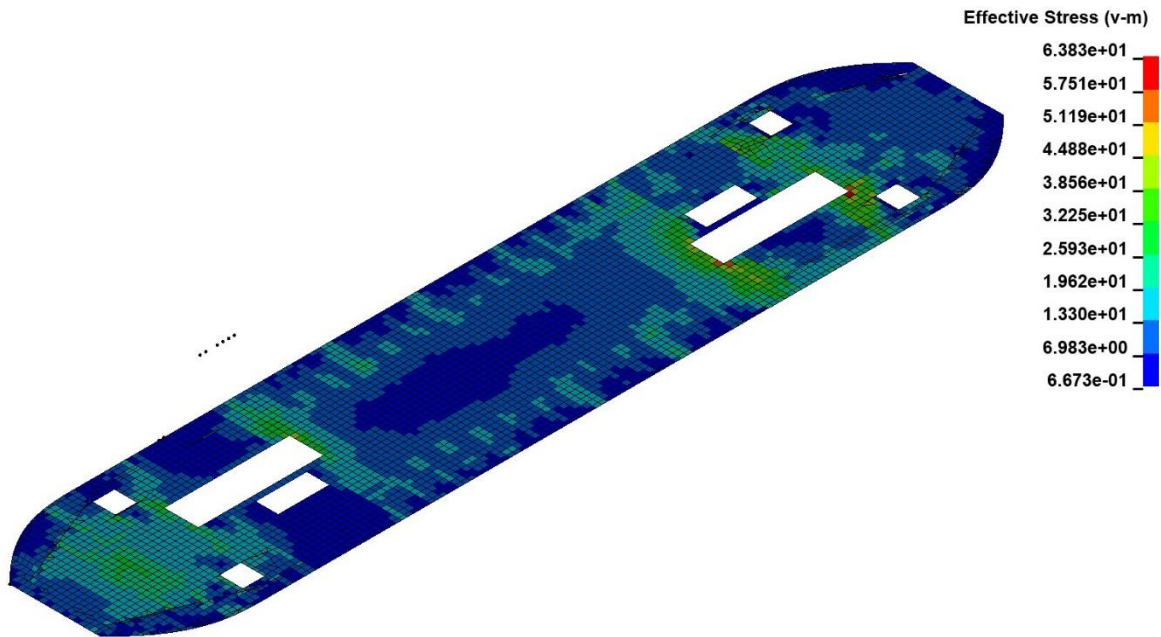


**Figure 73** Von Mises stress for global model

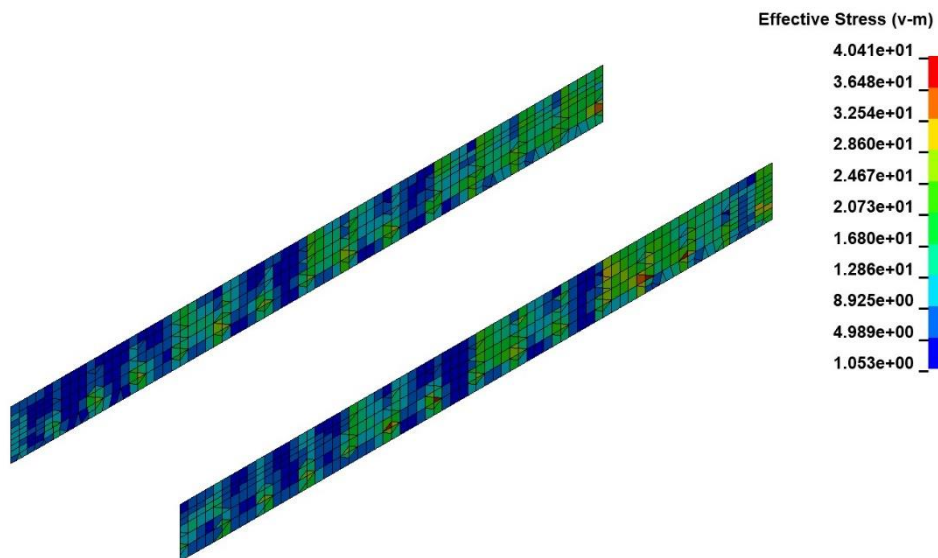


**Figure 74** Von Mises stress for Tank top

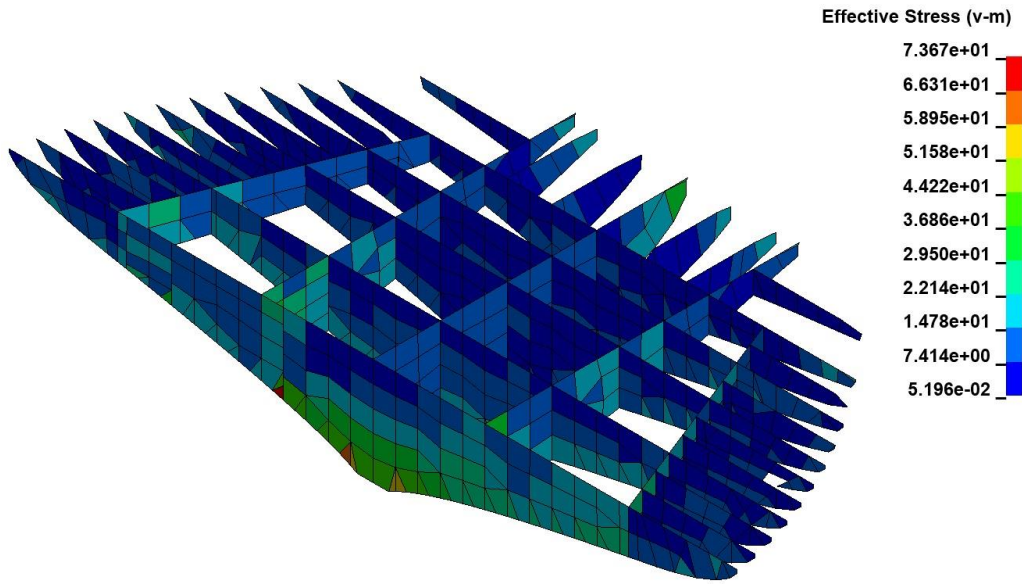




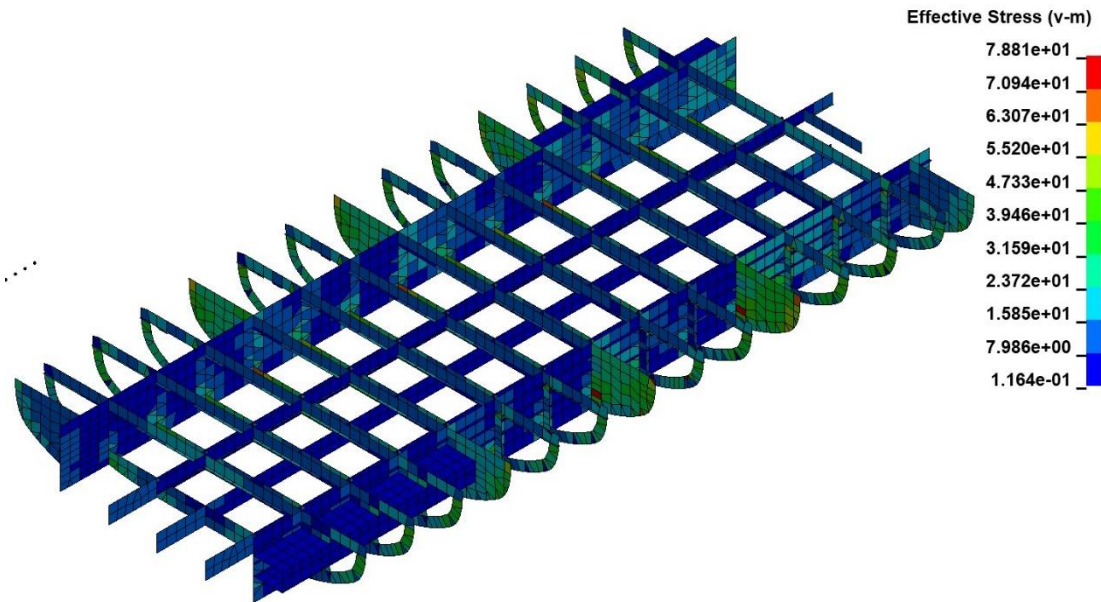
**Figure 75** Von Mises stress for Main deck



**Figure 76** Longitudinal bulkhead below Main deck on  $y = \pm 5800$

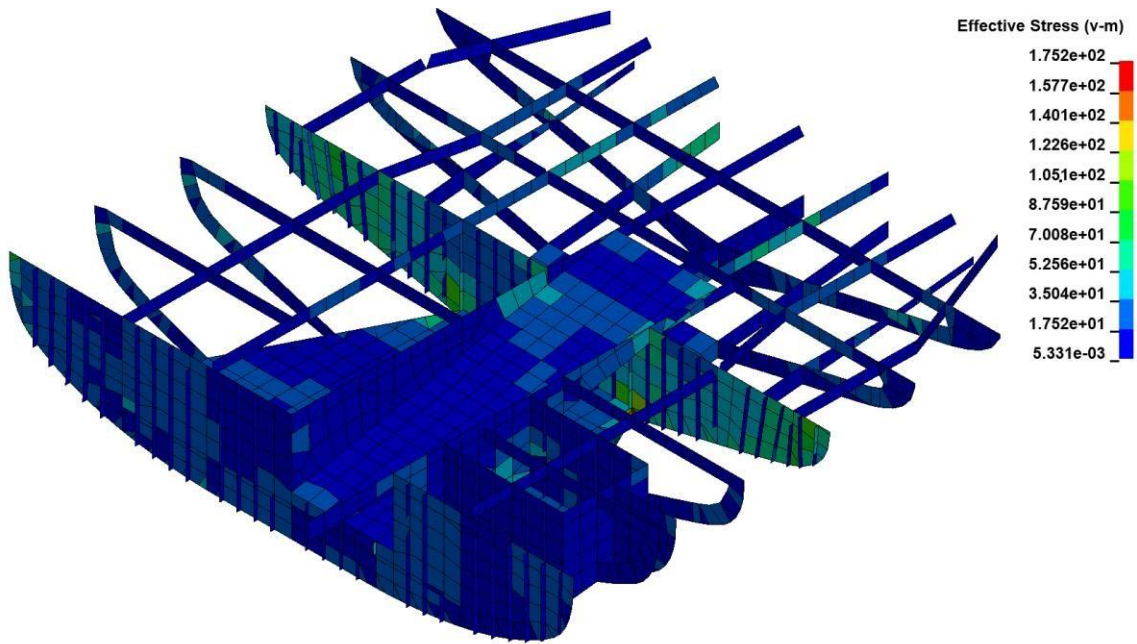


**Figure 77** Von Mises stress for structure below Main deck and between Fr50 and aft end (without stiffeners)

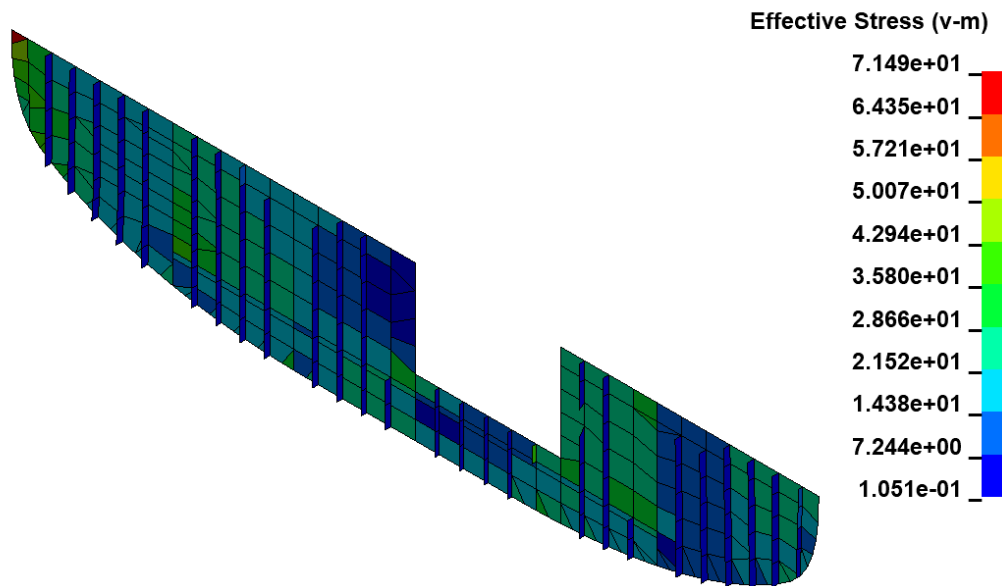


**Figure 78** Von Mises stress for structure between Fr35 – Fr-35 and below Tank top

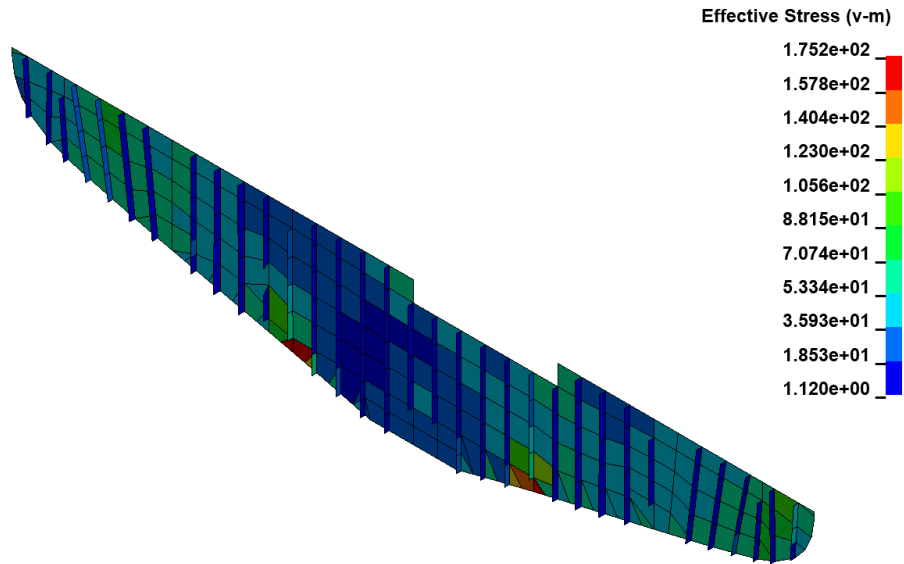




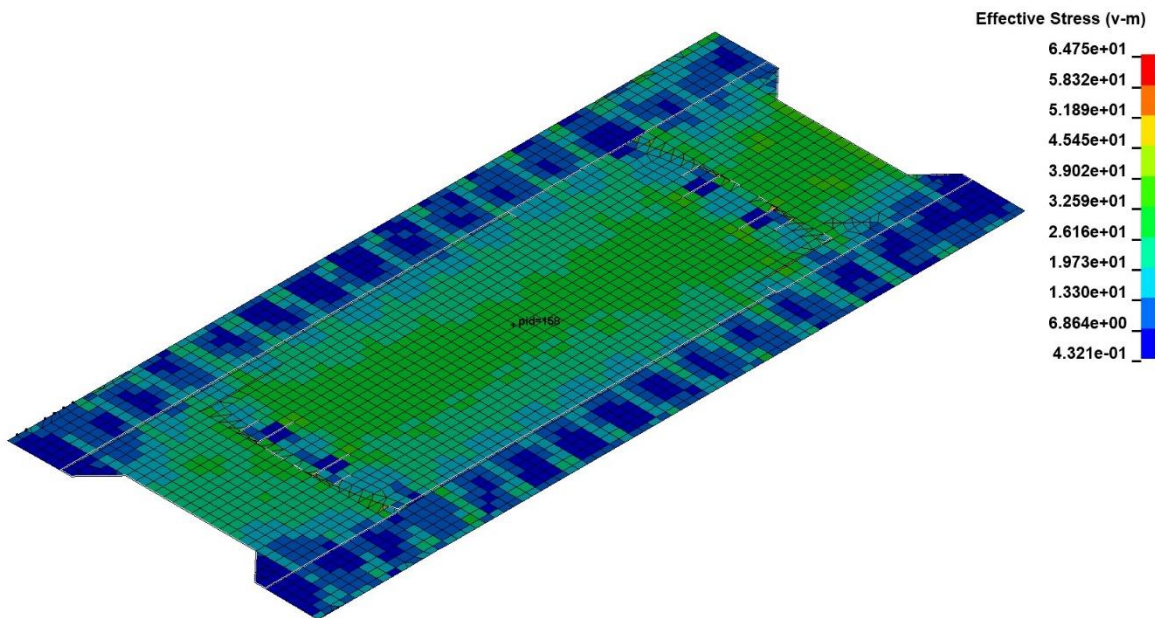
**Figure 79** Von Mises stress for structure below Main deck and between Fr35 and aft end



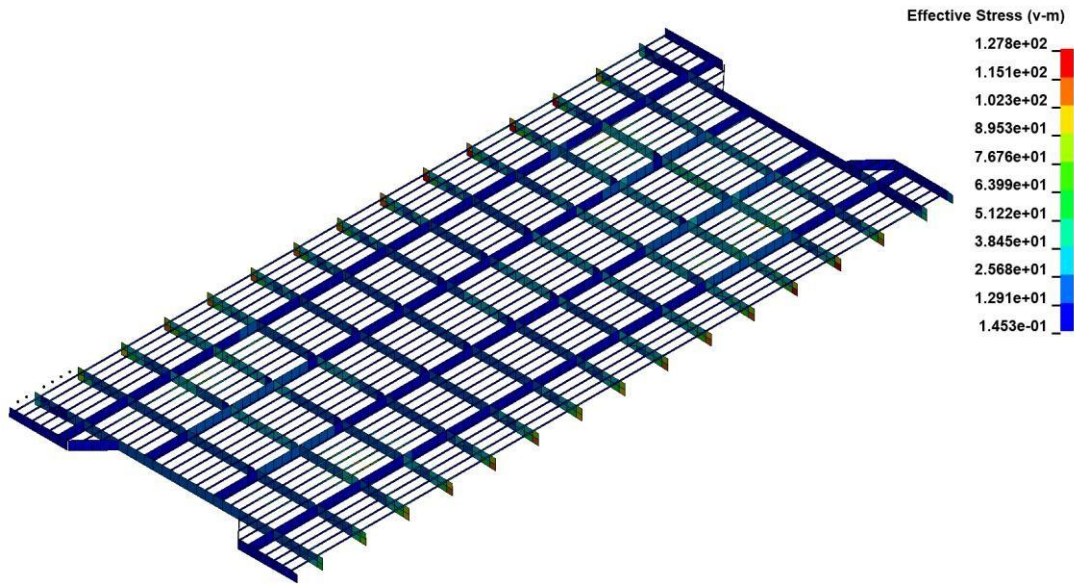
**Figure 80** Von Mises stress for transverse bulkhead on the Fr35



**Figure 81** Von Mises stress for transverse bulkhead on the Fr50

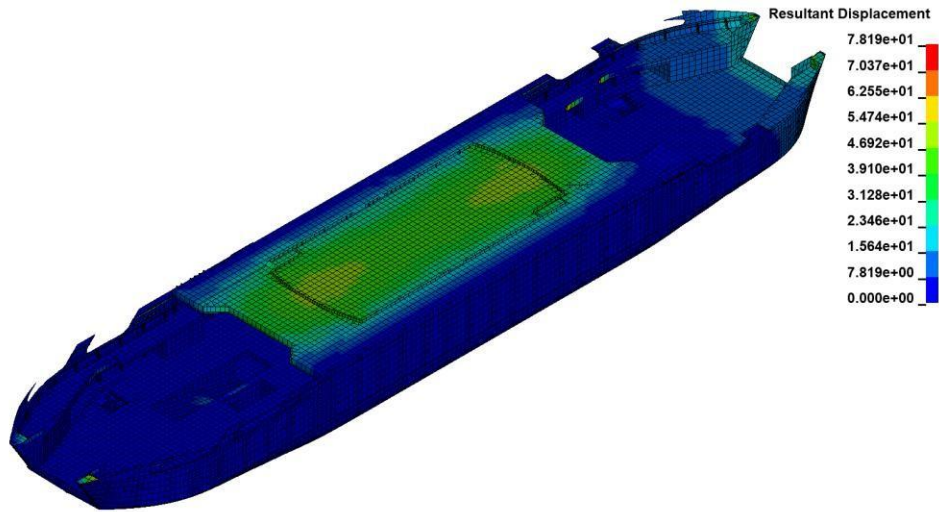


**Figure 82** Von Mises stress for Passenger deck



**Figure 83** Von Mises stress for structure below Passenger deck

### 3.5.5. Simulation 2.2.



**Figure 84** Global isometric view of resultant displacement

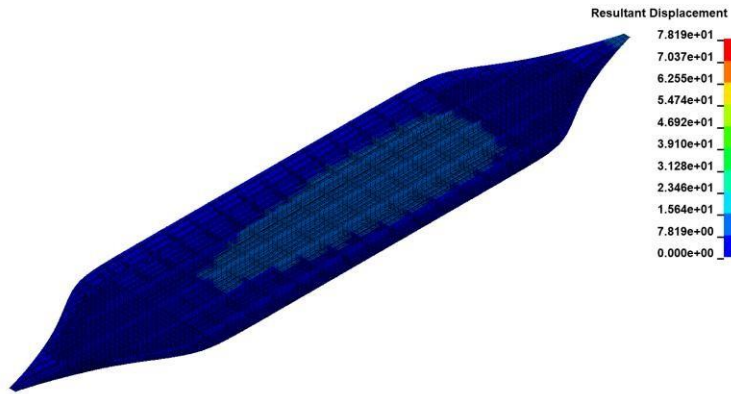


**Figure 85** Global side view of resultant displacement scaled by 50

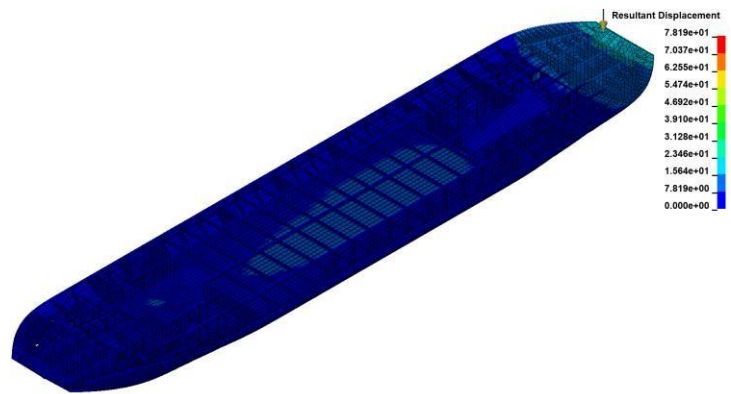


**Figure 86** Global side view of resultant displacement scaled by 100

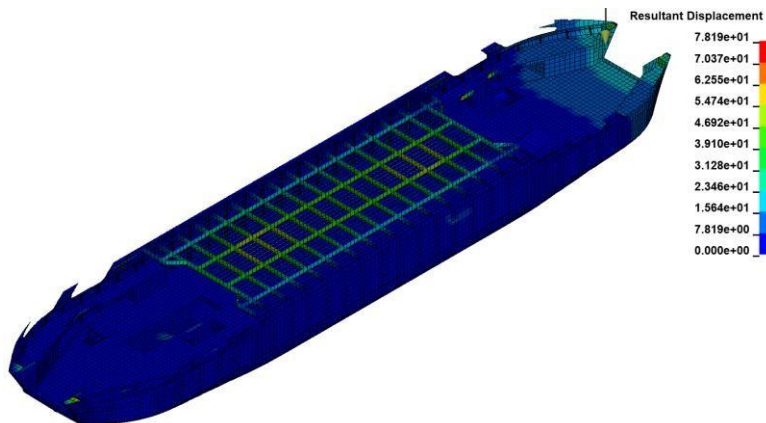




**Figure 87** *Global isometric section view of resultant displacement up to the Tank top*

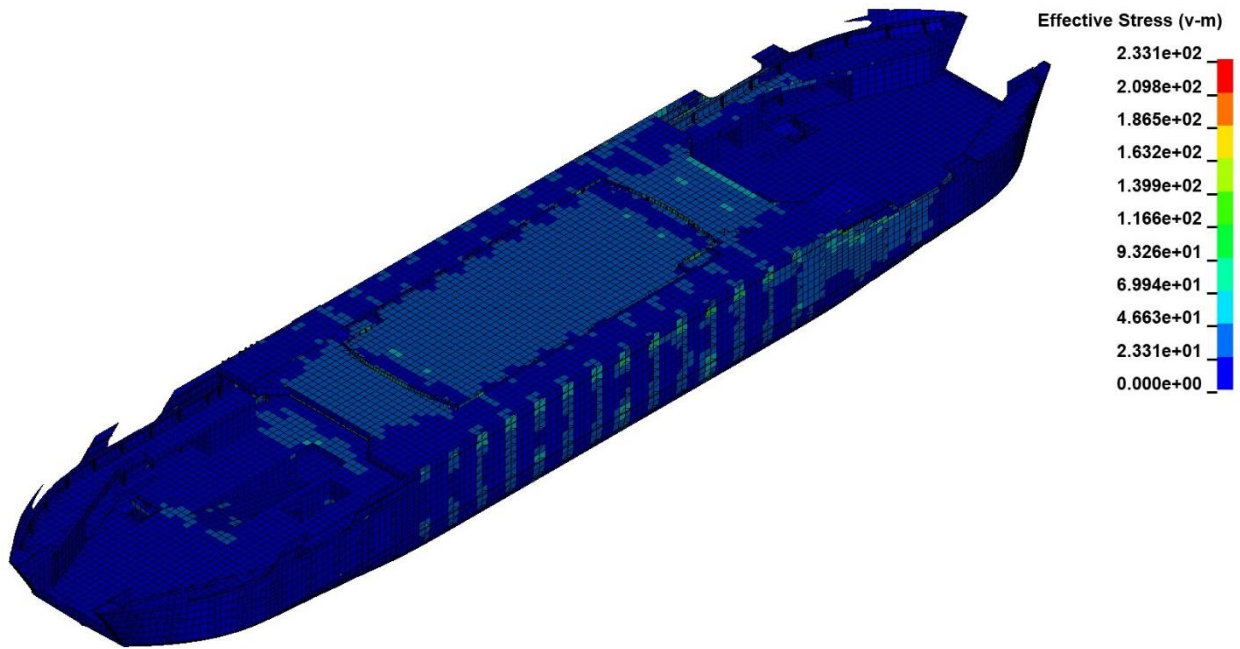


**Figure 88** *Global isometric section view of resultant displacement up to the Main deck*

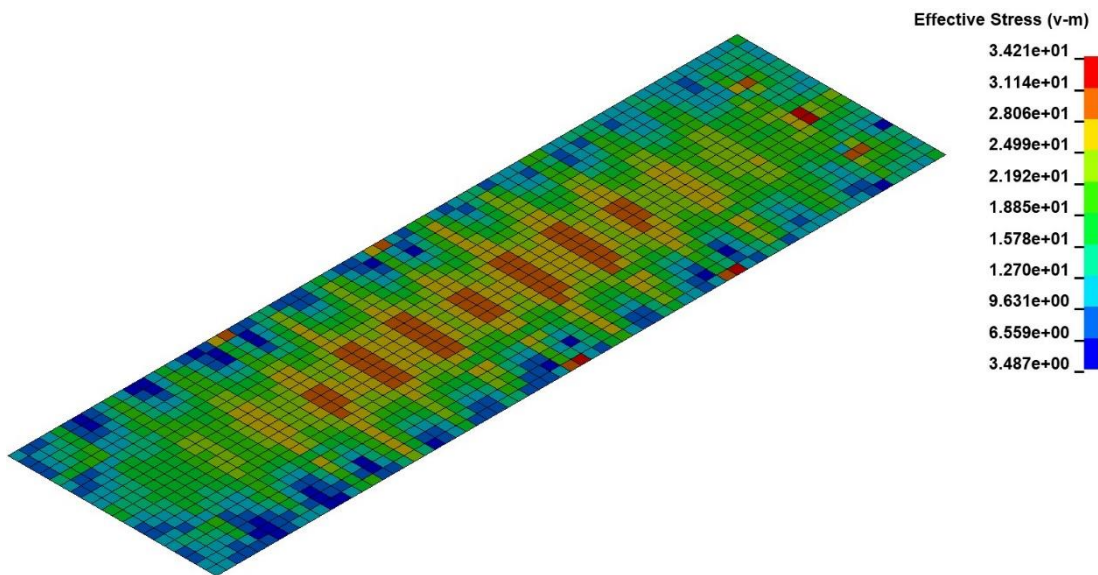


**Figure 89** *Global isometric section view of resultant displacement up to the Passenger deck*

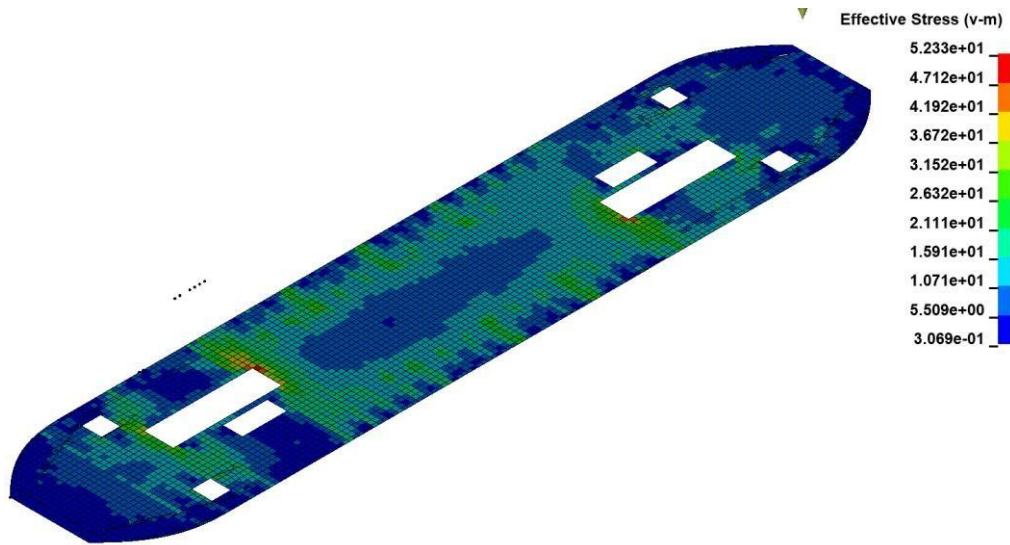




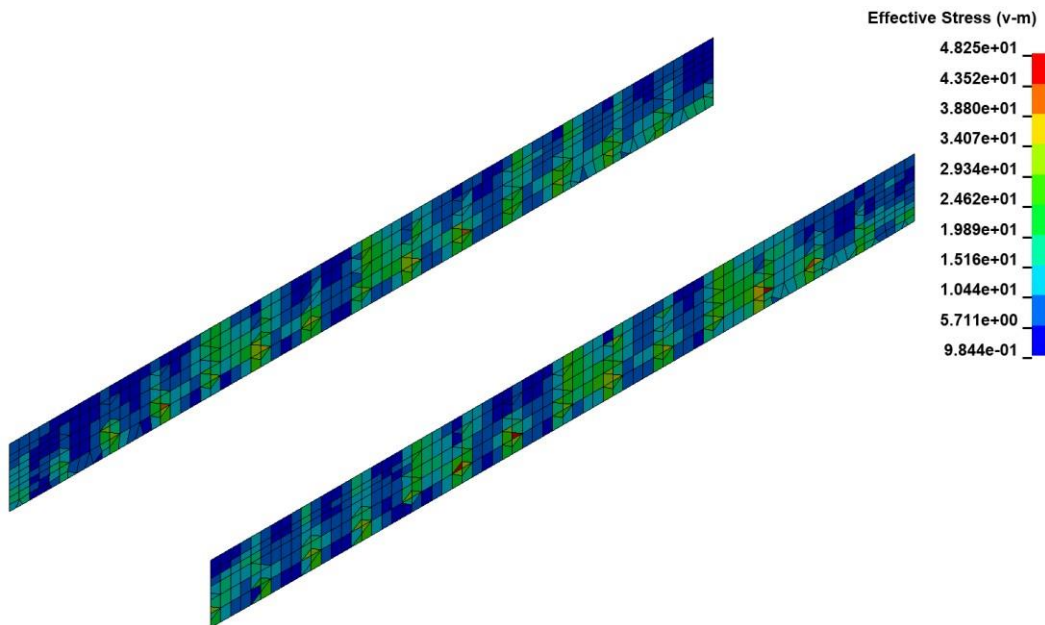
**Figure 90** Von Mises stress for global model



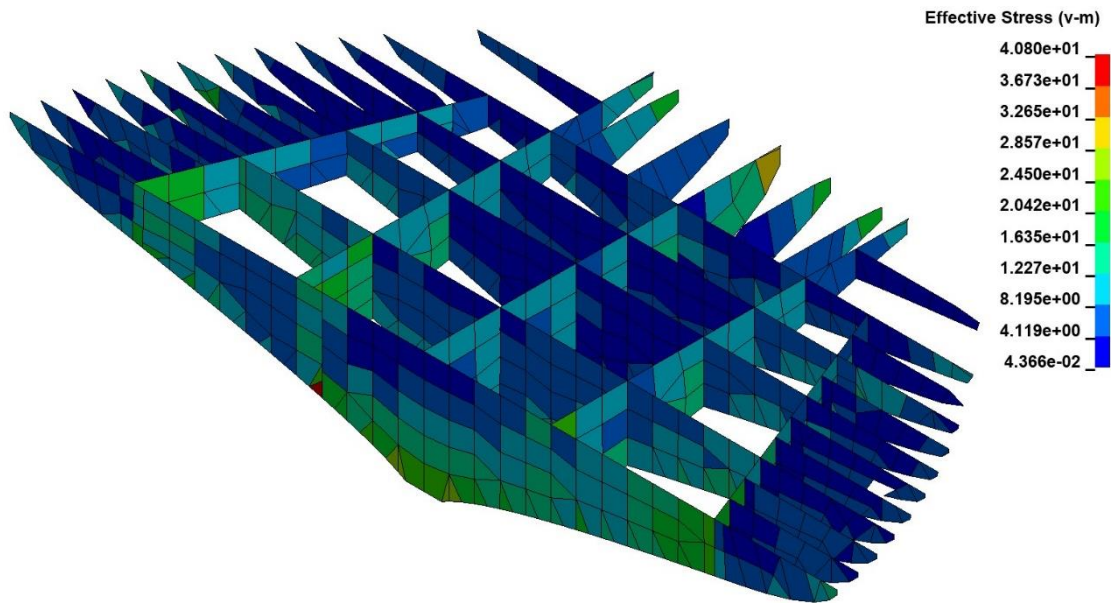
**Figure 91** Von Mises stress for Tank top



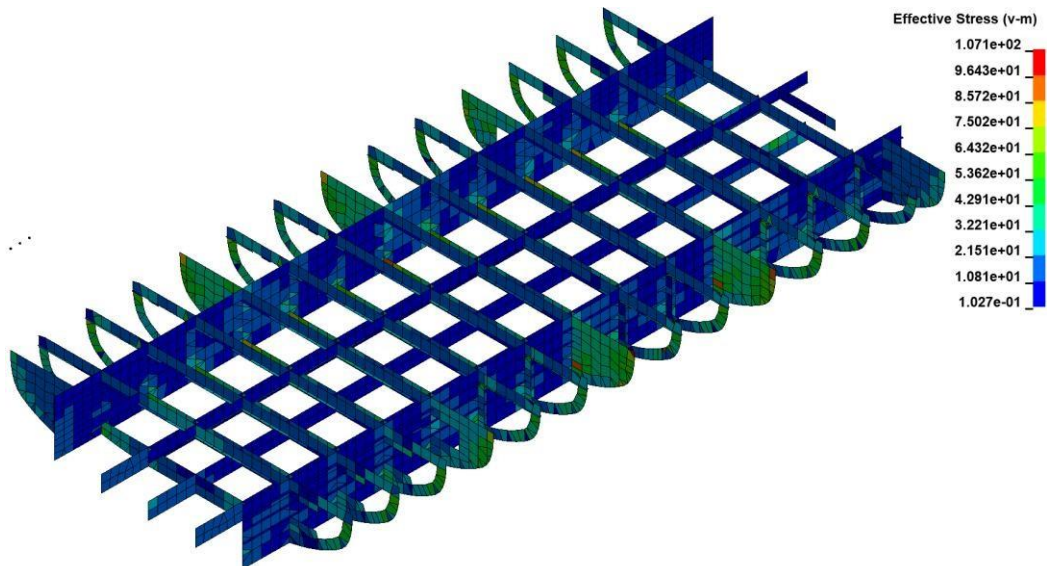
**Figure 92** Von Mises stress for Main deck



**Figure 93** Longitudinal bulkhead below Main deck on  $y = \pm 5800$

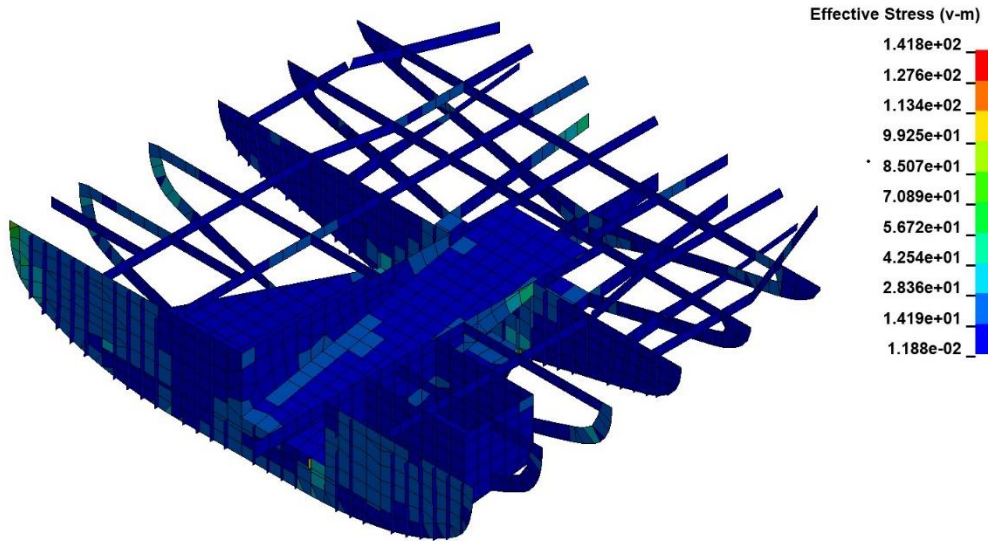


**Figure 94** Von Mises stress for structure below Main deck and between Fr50 and aft end (without stiffeners)

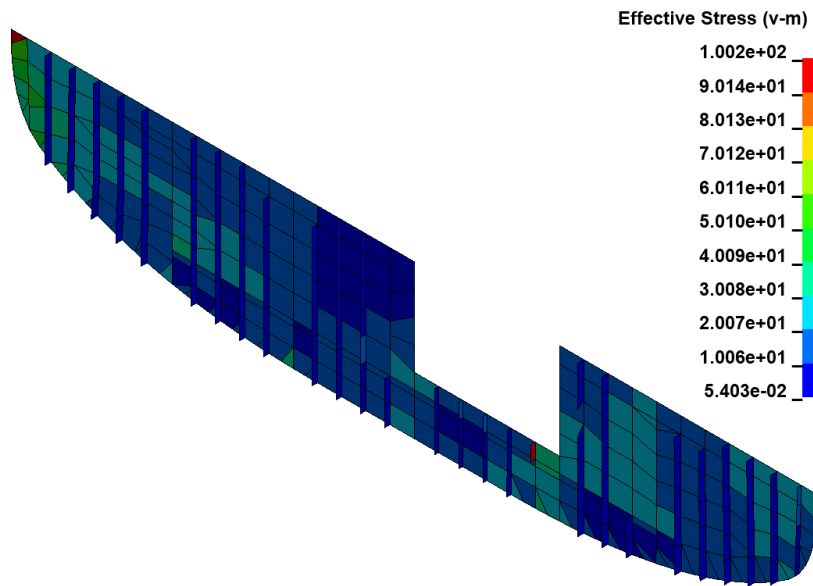


**Figure 95** Von Mises stress for structure between Fr35 – Fr-35 and below Tank top

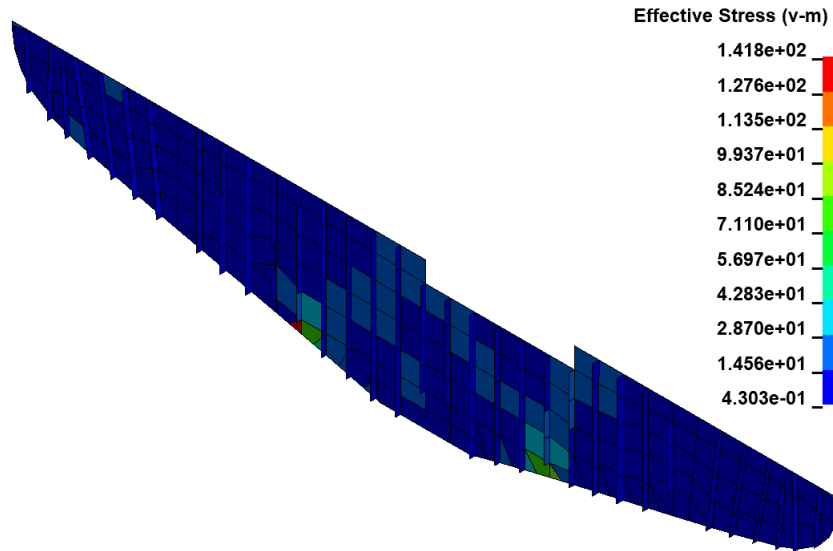




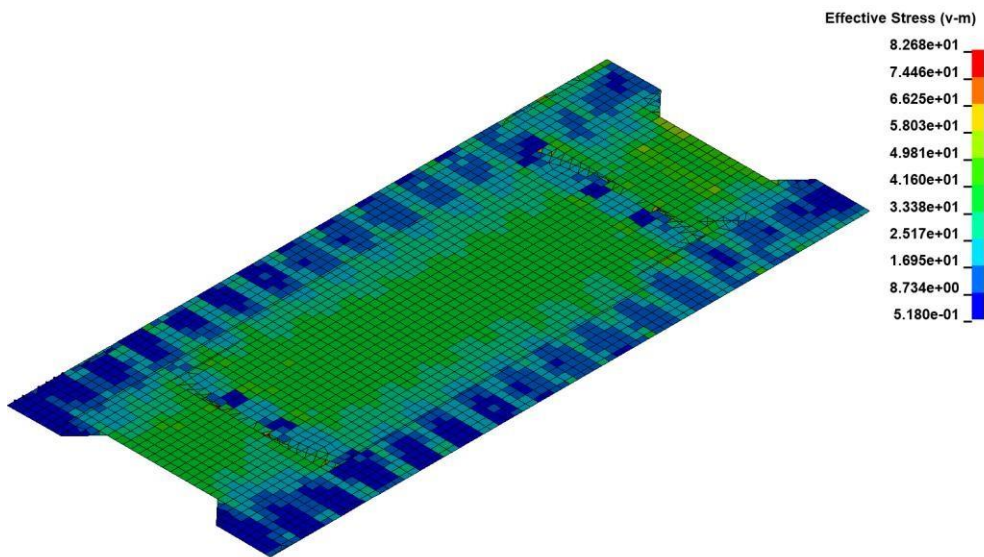
**Figure 96** Von Mises stress for structure below Main deck and between Fr35 and aft end



**Figure 97** Von Mises stress for transverse bulkhead on the Fr35

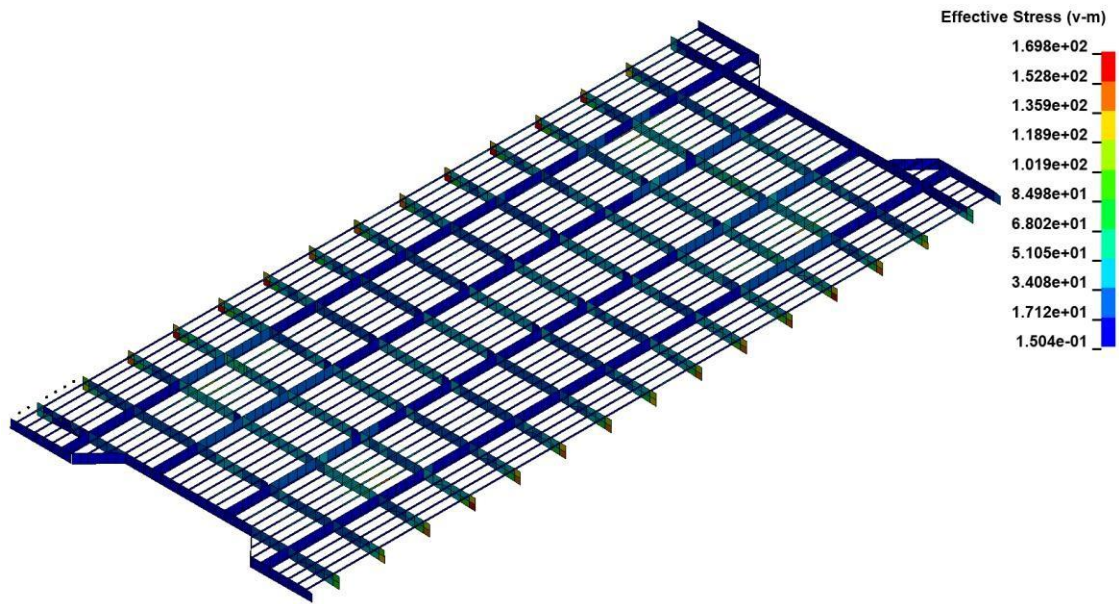


**Figure 98** Von Mises stress for transverse bulkhead on the Fr50



**Figure 99** Von Mises stress for Passenger deck





**Figure 100** Von Mises stress for structure below Passenger deck

### 3.5.6. Simulation 2.3.

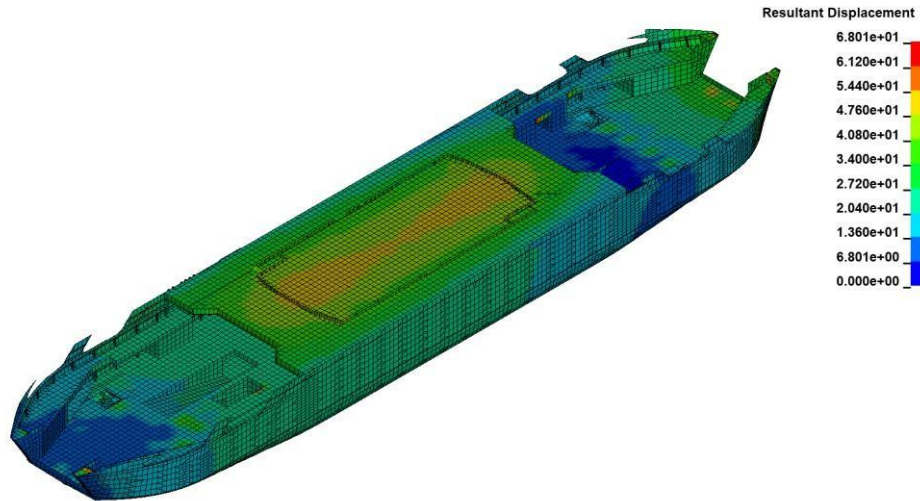


Figure 101 Global isometric view of resultant displacement

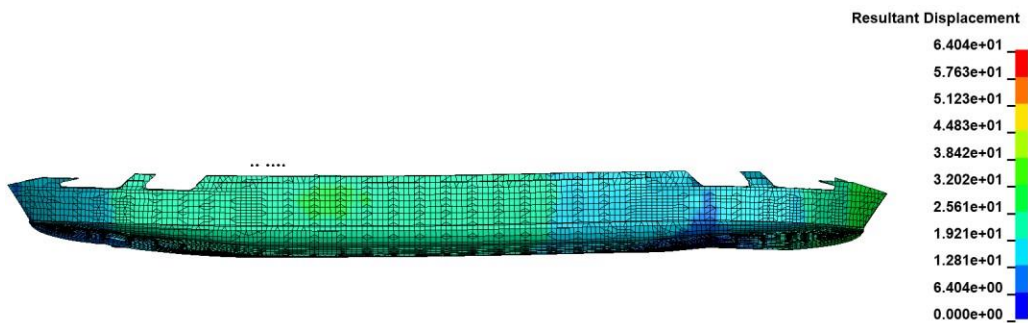


Figure 102 Global side view of resultant displacement scaled by 50

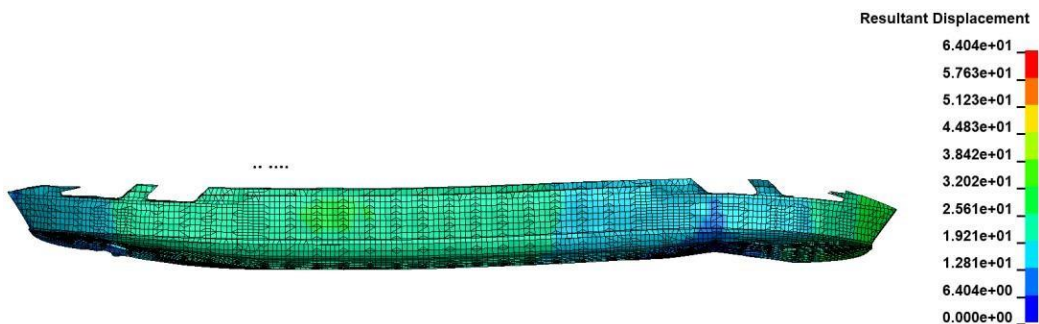
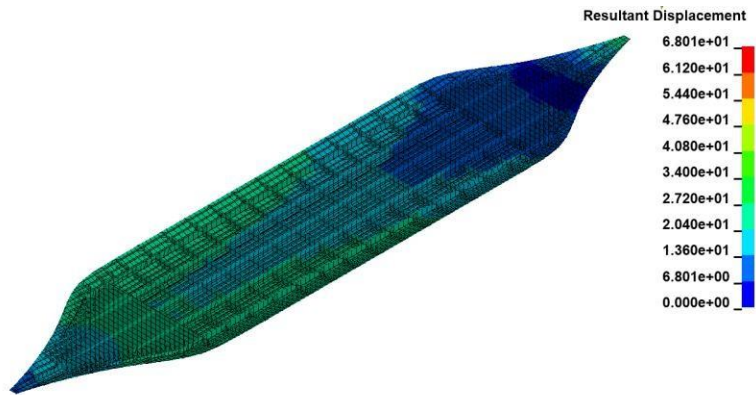
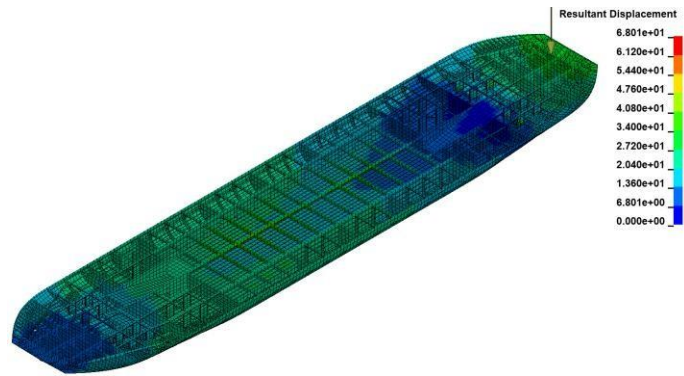


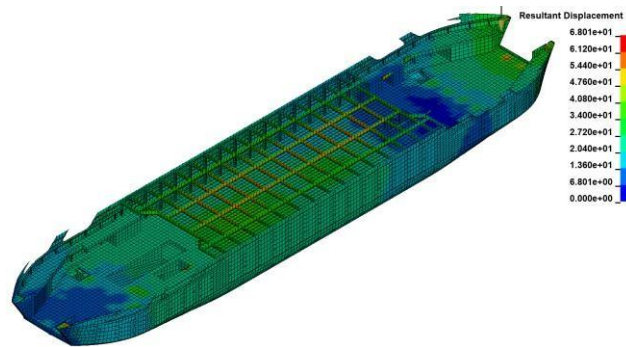
Figure 103 Global side view of resultant displacement scaled by 100



**Figure 104** *Global isometric section view of resultant displacement up to the Tank top*

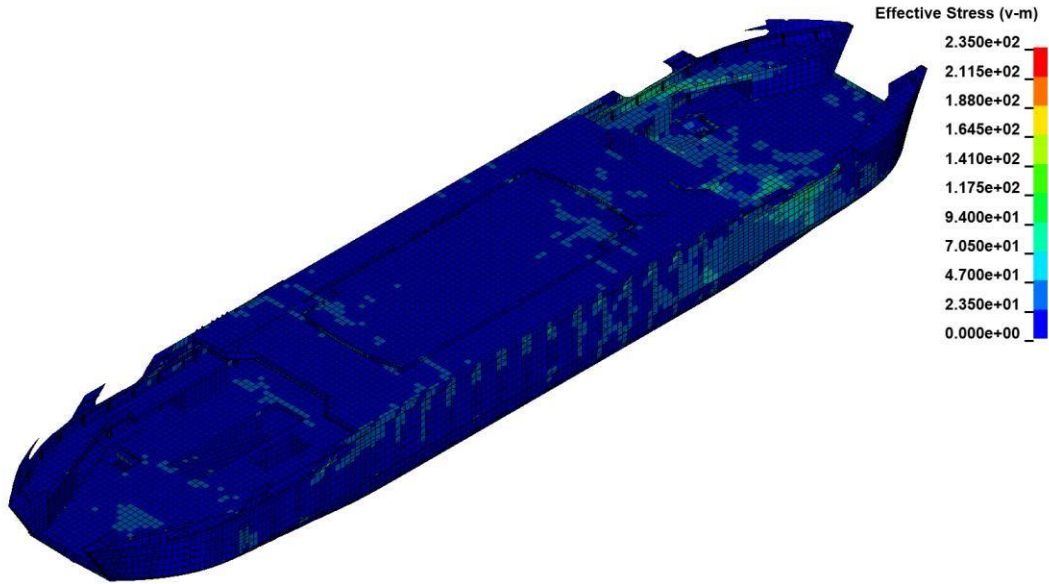


**Figure 105** *Global isometric section view of resultant displacement up to the Main deck*

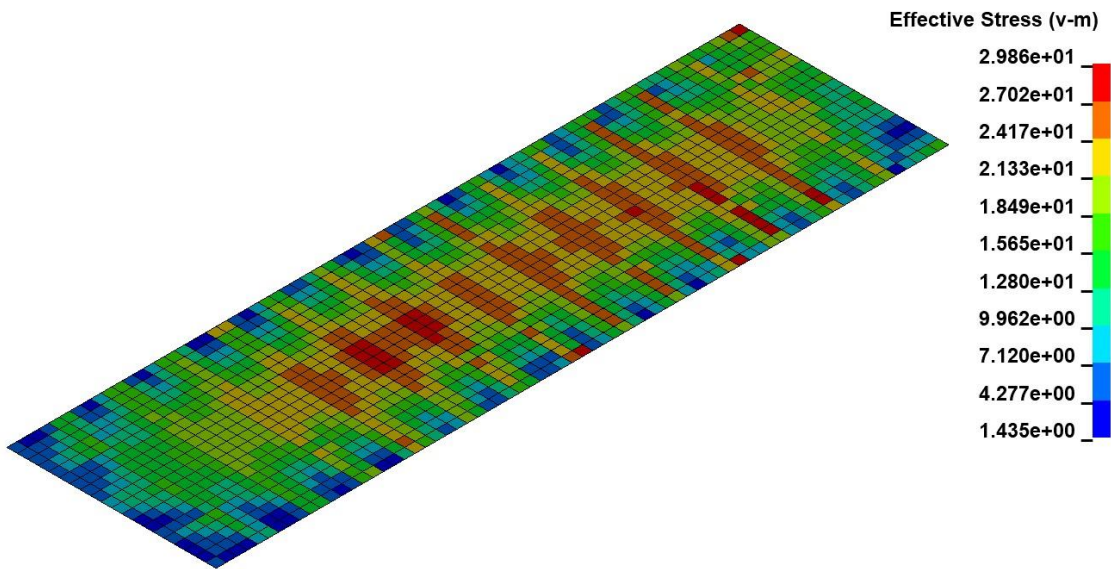


**Figure 106** *Global isometric section view of resultant displacement up to the Passenger deck*

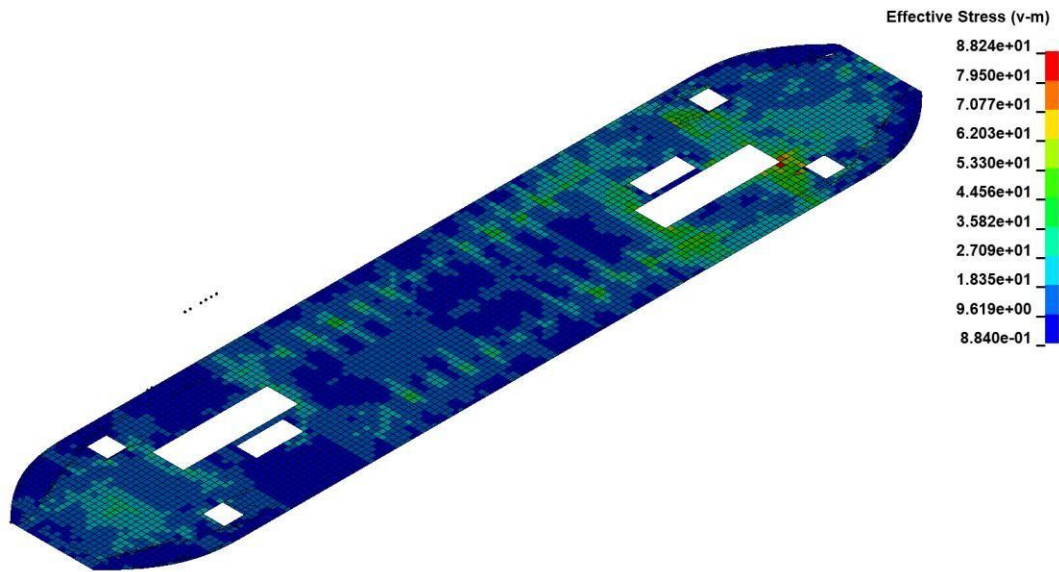




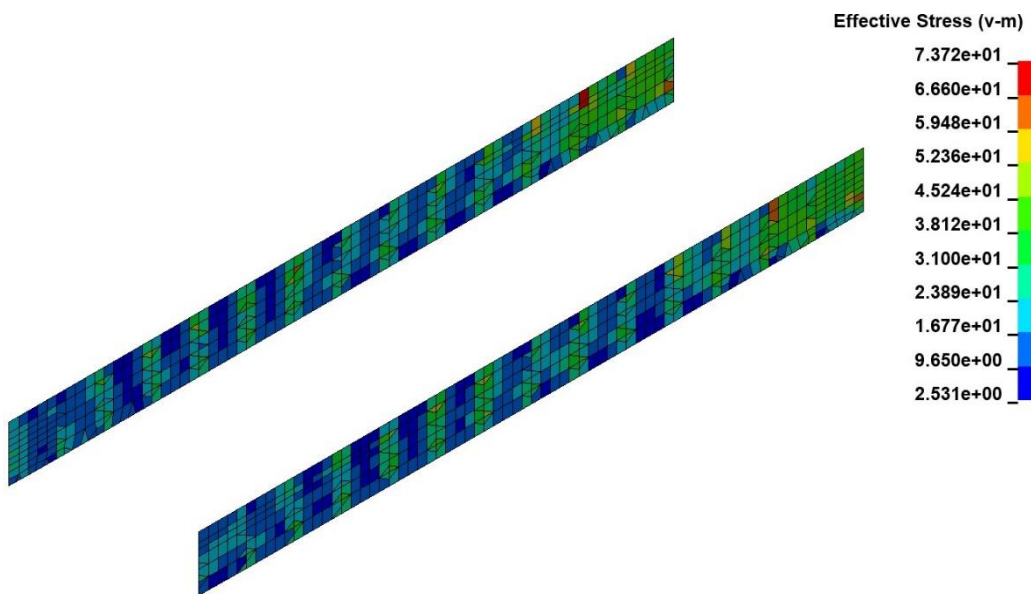
**Figure 107** *Von Mises stress for global model*



**Figure 108** *Von Mises stress for Tank top*

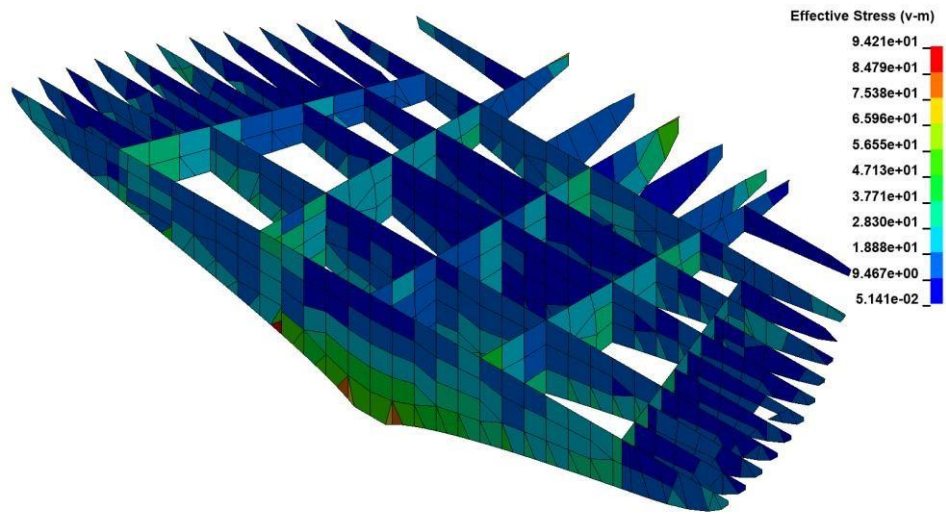


**Figure 109** Von Mises stress for Main deck

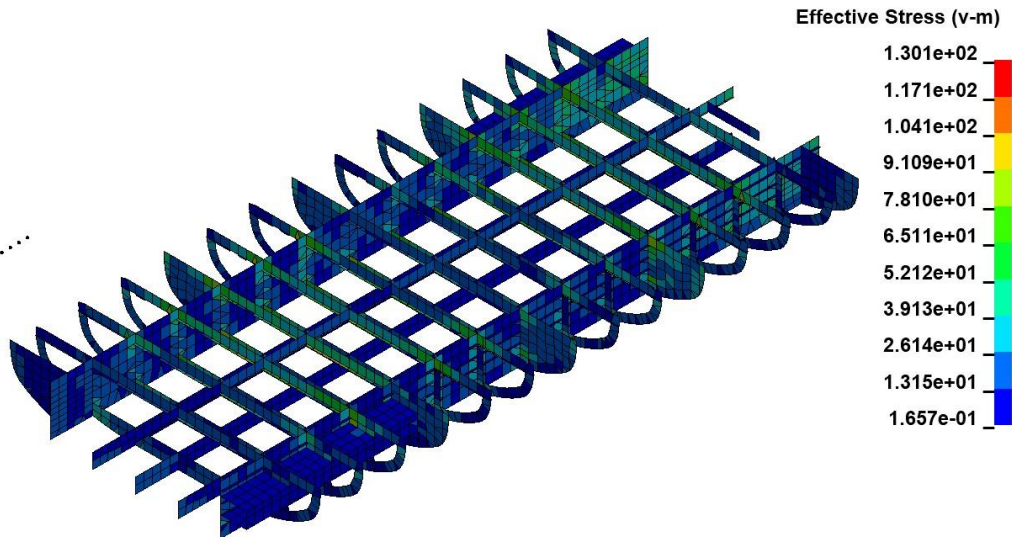


**Figure 110** Longitudinal bulkhead below Main deck on  $y = \pm 5800$

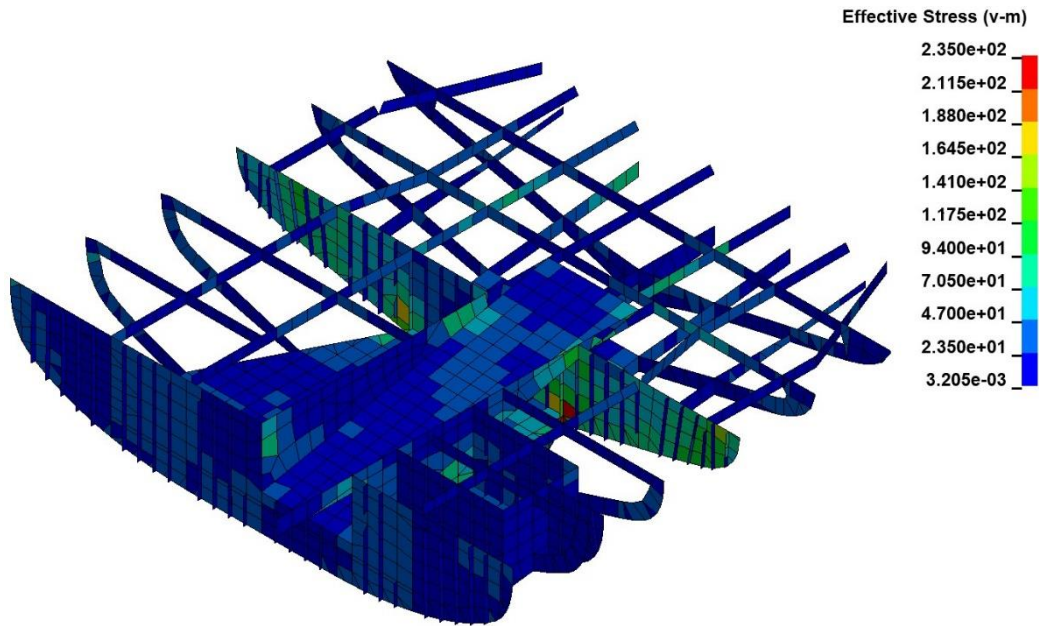




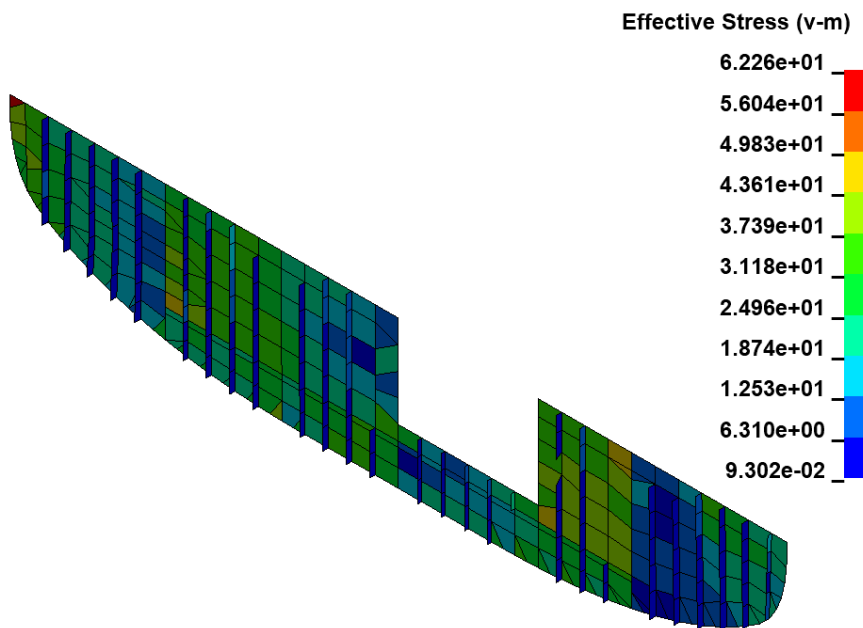
**Figure 111** Von Mises stress for structure below Main deck and between Fr50 and aft end (without stiffeners)



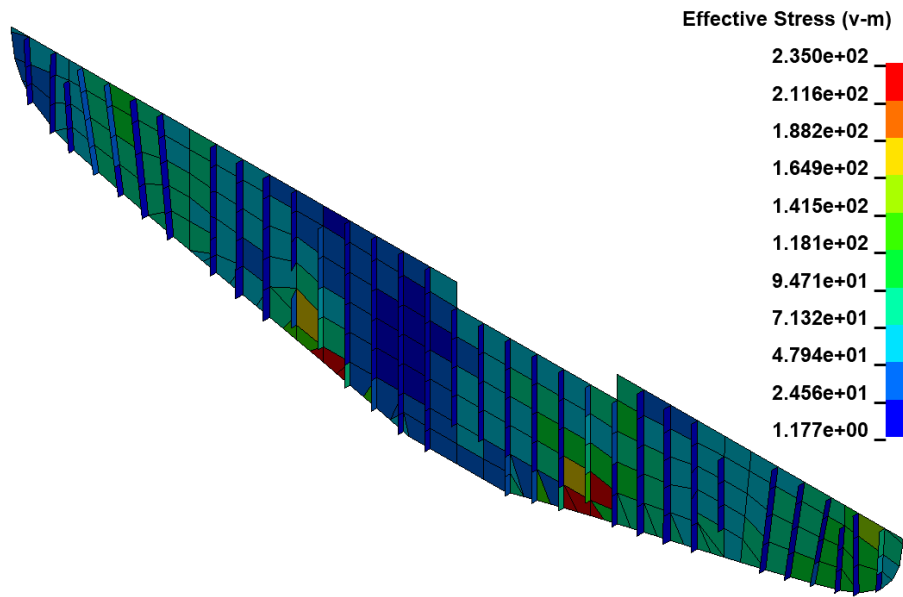
**Figure 112** Von Mises stress for structure between Fr35 – Fr-35 and below Tank top



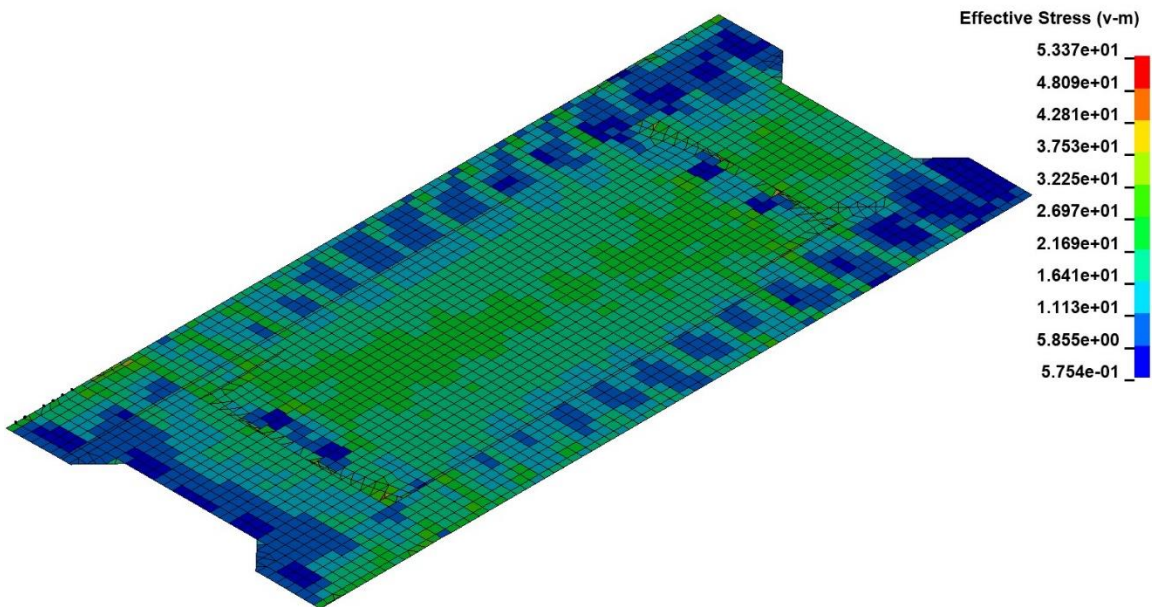
**Figure 113** Von Mises stress for structure below Main deck and between Fr35 and aft end



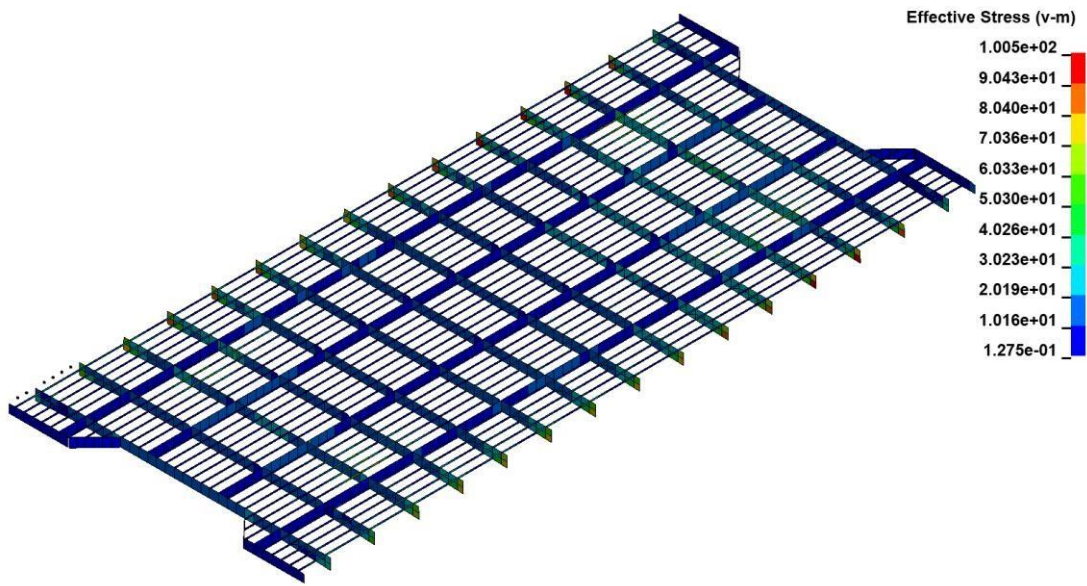
**Figure 114** Von Mises stress for transverse bulkhead on the Fr35



**Figure 115** Von Mises stress for transverse bulkhead on the Fr50



**Figure 116** Von Mises stress for Passenger deck



**Figure 117** Von Mises stress for structure below Passenger deck



### 3.5.7. Simulation 3.1.

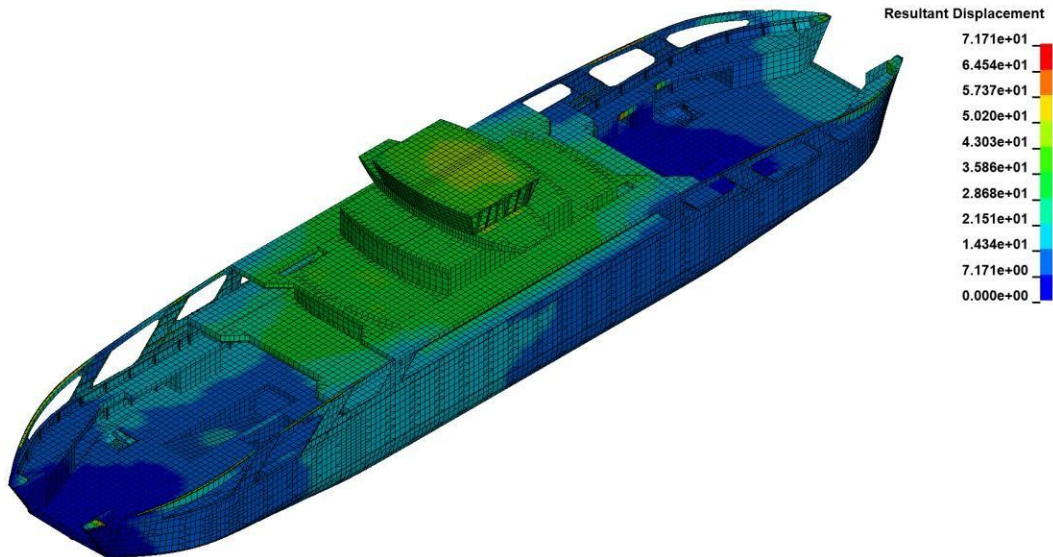


Figure 118 Global isometric view of resultant displacement

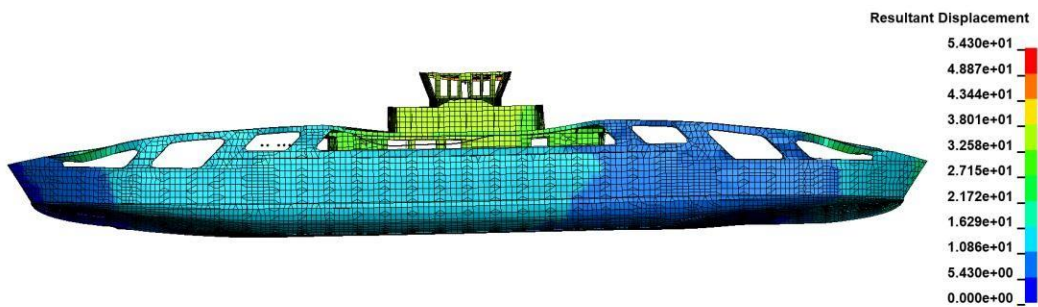


Figure 119 Global side view of resultant displacement scaled by 50

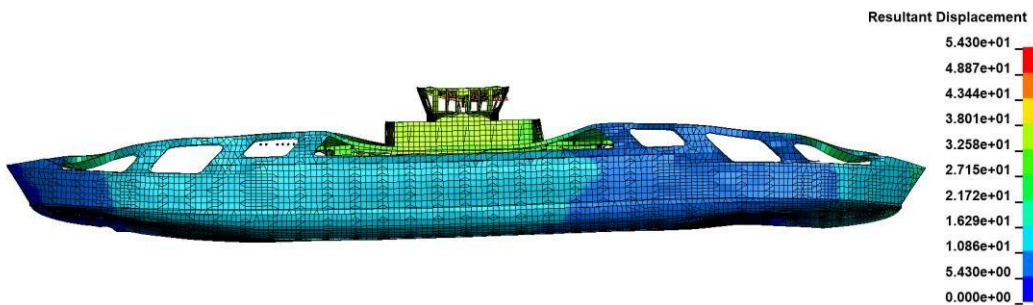
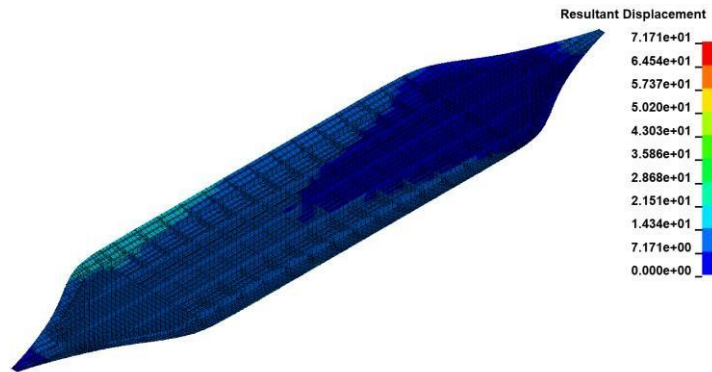
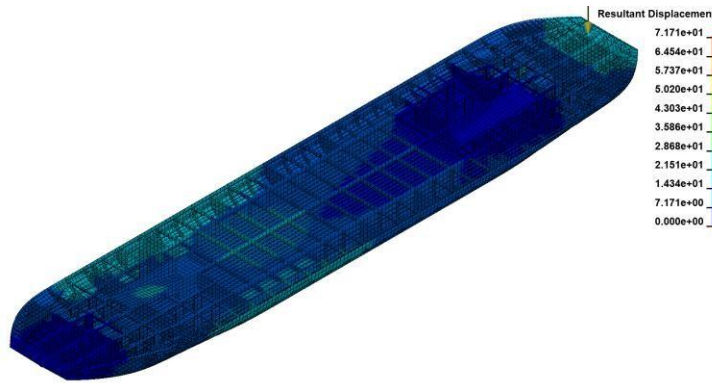


Figure 120 Global side view of resultant displacement scaled by 100

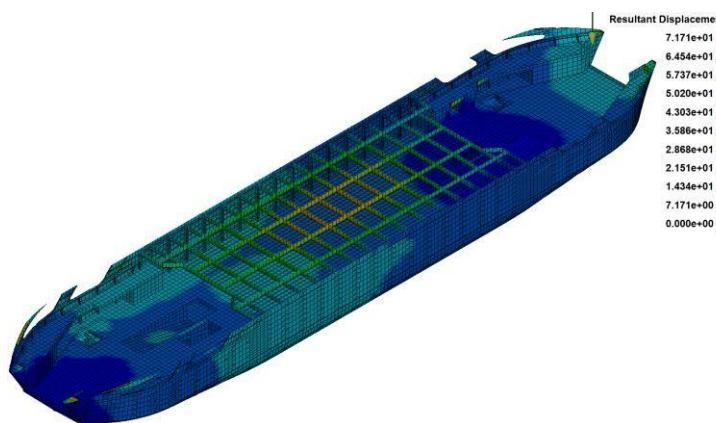




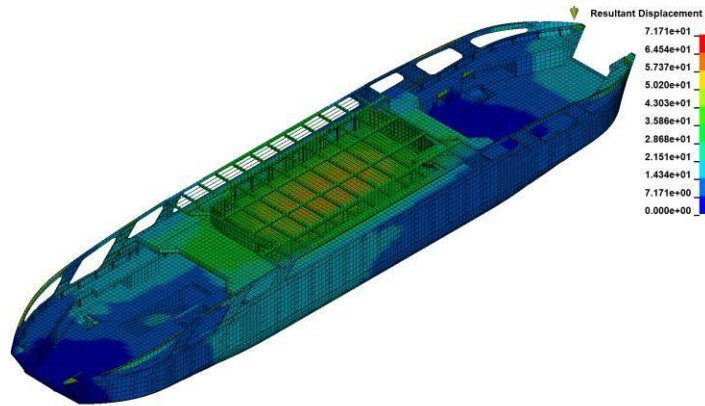
**Figure 121** Global isometric section view of resultant displacement up to the Tank top



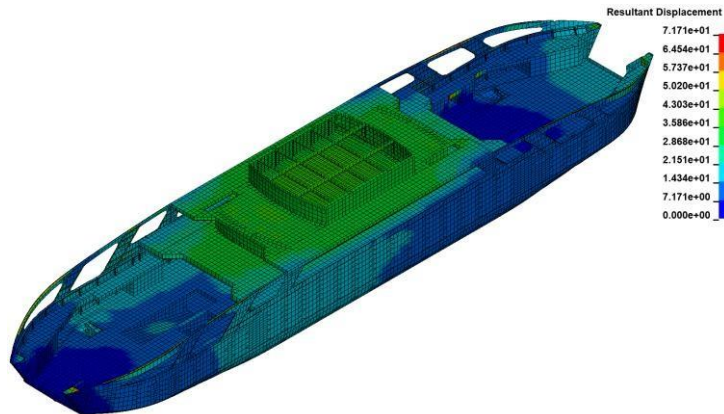
**Figure 122** Global isometric section view of resultant displacement up to the Main deck



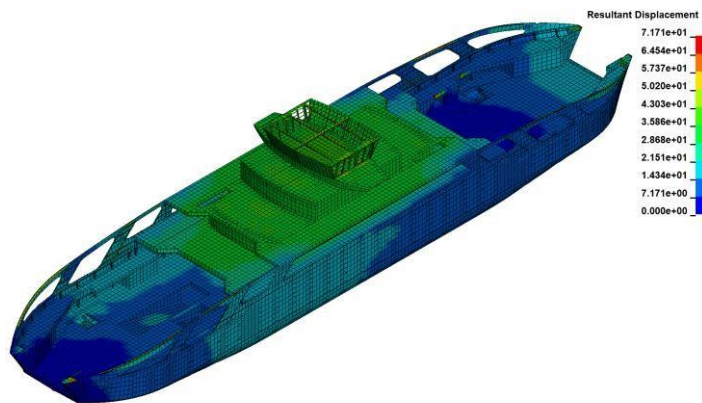
**Figure 123** Global isometric section view of resultant displacement up to the Passenger deck



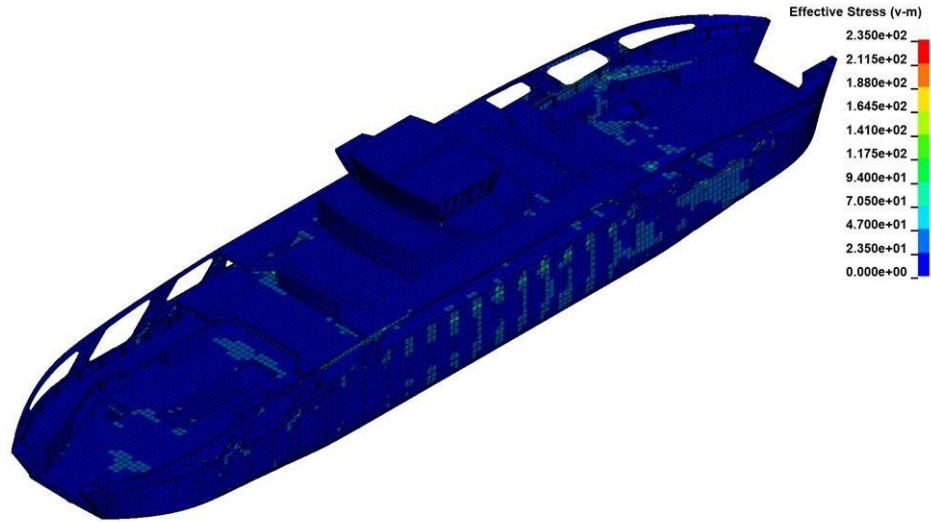
**Figure 124** *Global isometric section view of resultant displacement up to the Sun deck*



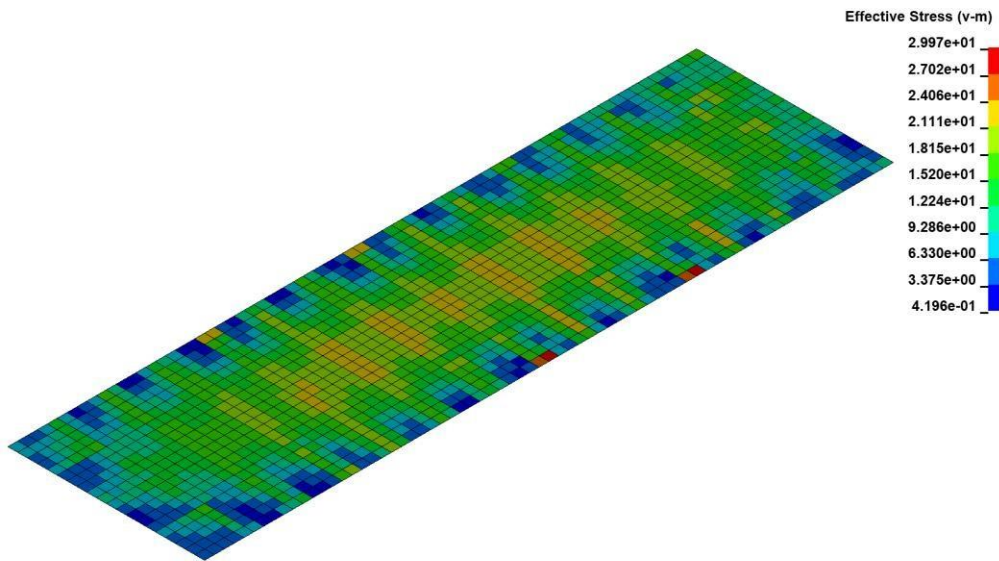
**Figure 125** *Global isometric section view of resultant displacement up to the Superstructure top*



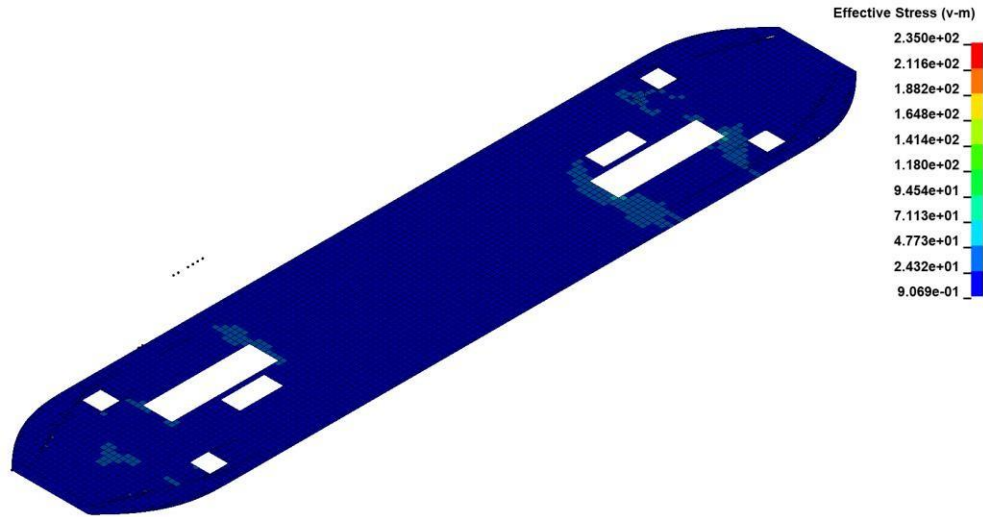
**Figure 126** *Global isometric section view of resultant displacement up to the Wheelhouse top*



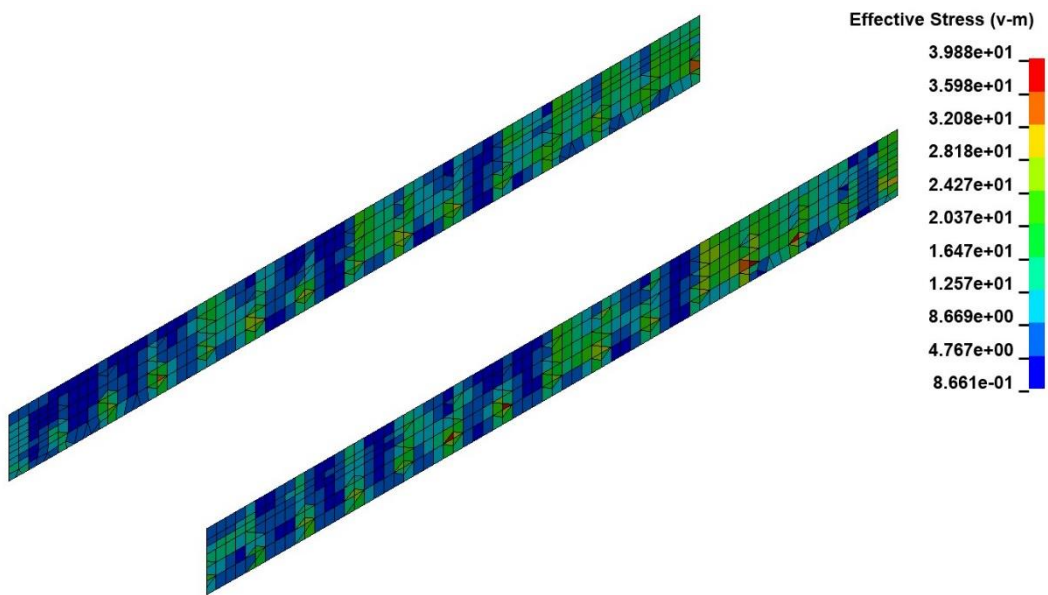
**Figure 127** Von Mises stress for global model



**Figure 128** Von Mises stress for Tank top

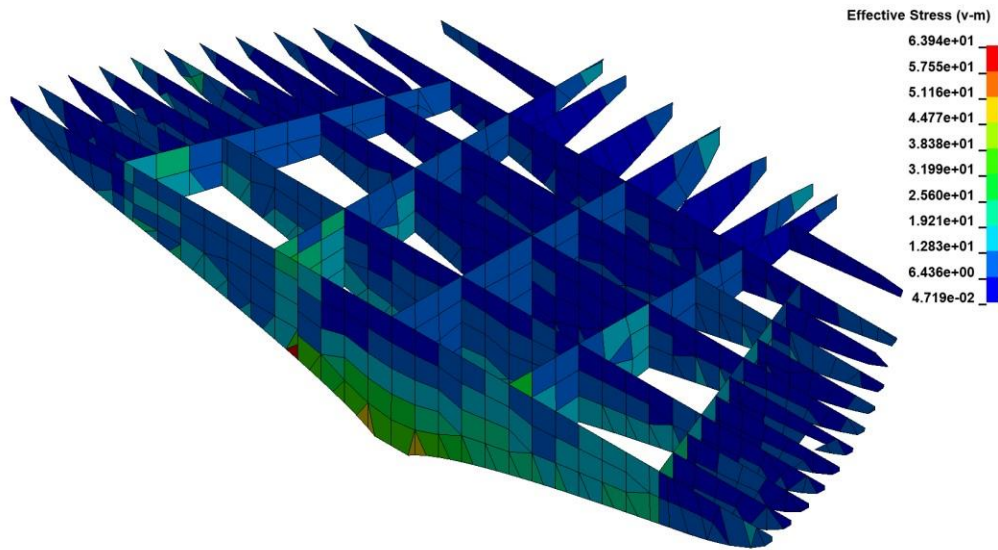


**Figure 129** Von Mises stress for Main deck

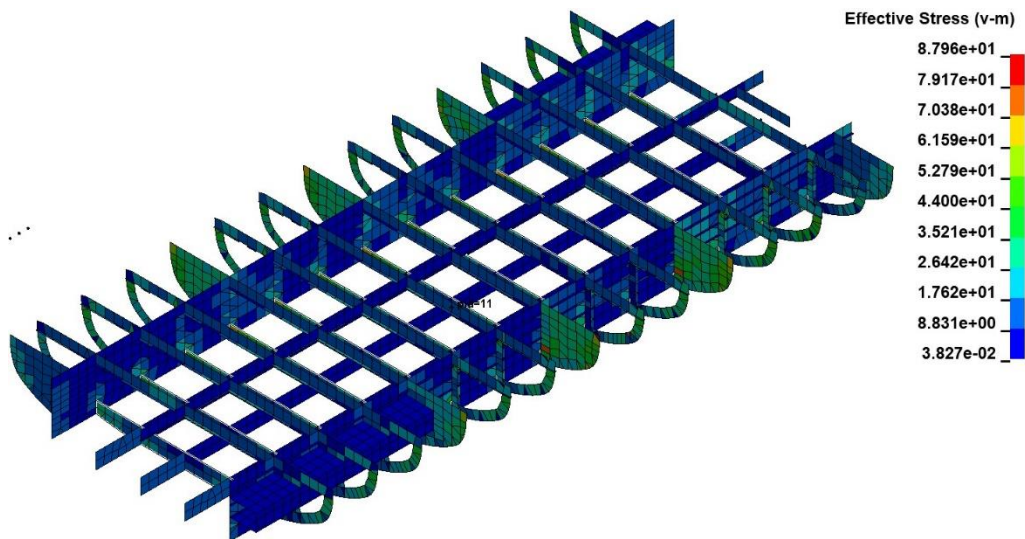


**Figure 130** Longitudinal bulkhead below Main deck on  $y = \pm 5800$

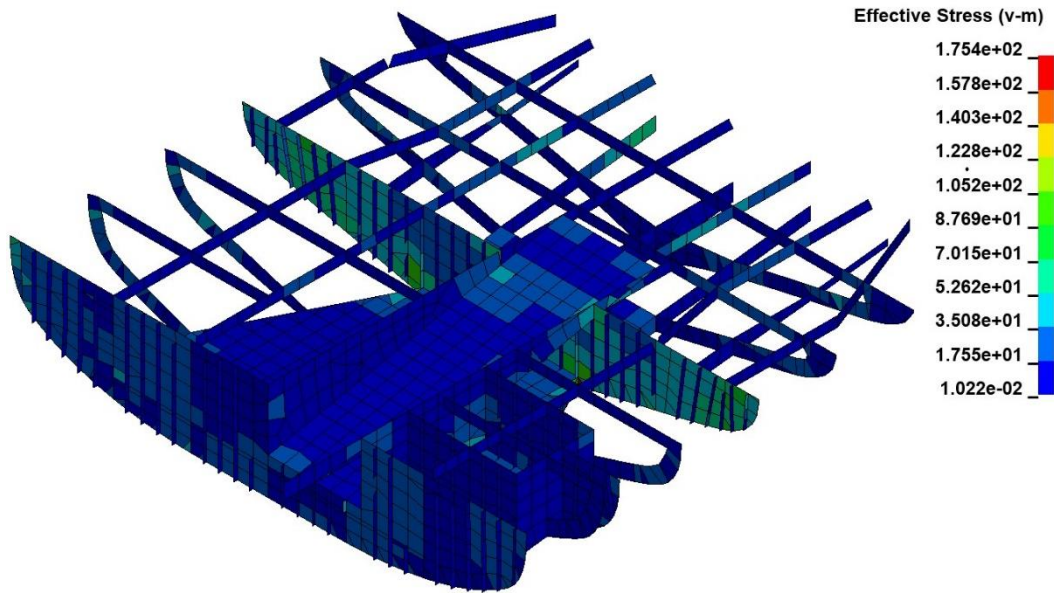




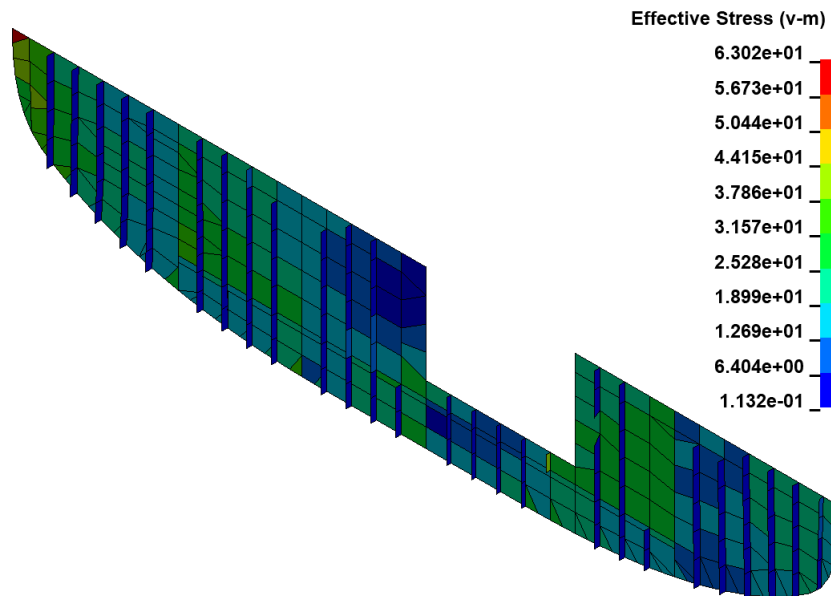
**Figure 131** Von Mises stress for structure below Main deck and between Fr50 and aft end (without stiffeners)



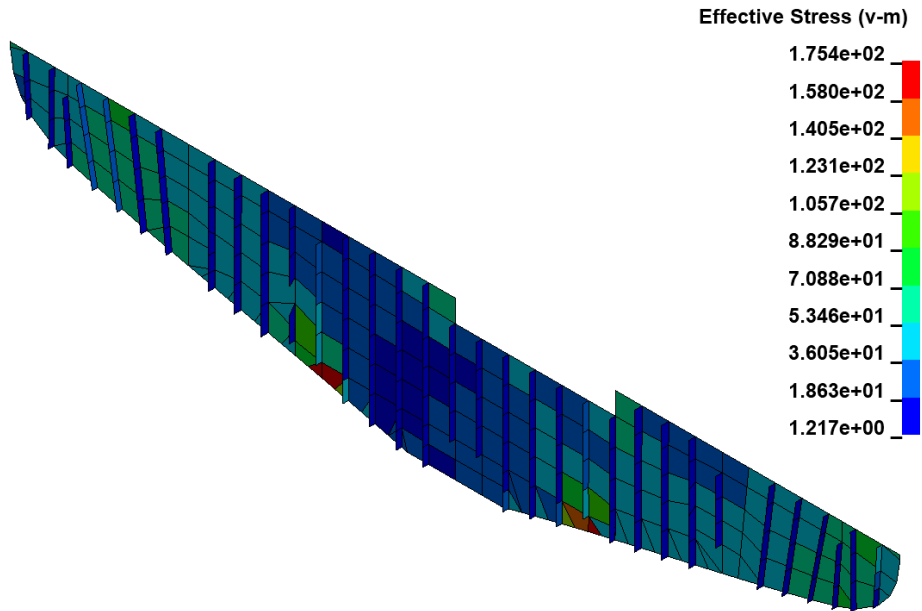
**Figure 132** Von Mises stress for structure between Fr35 – Fr-35 and below Tank top



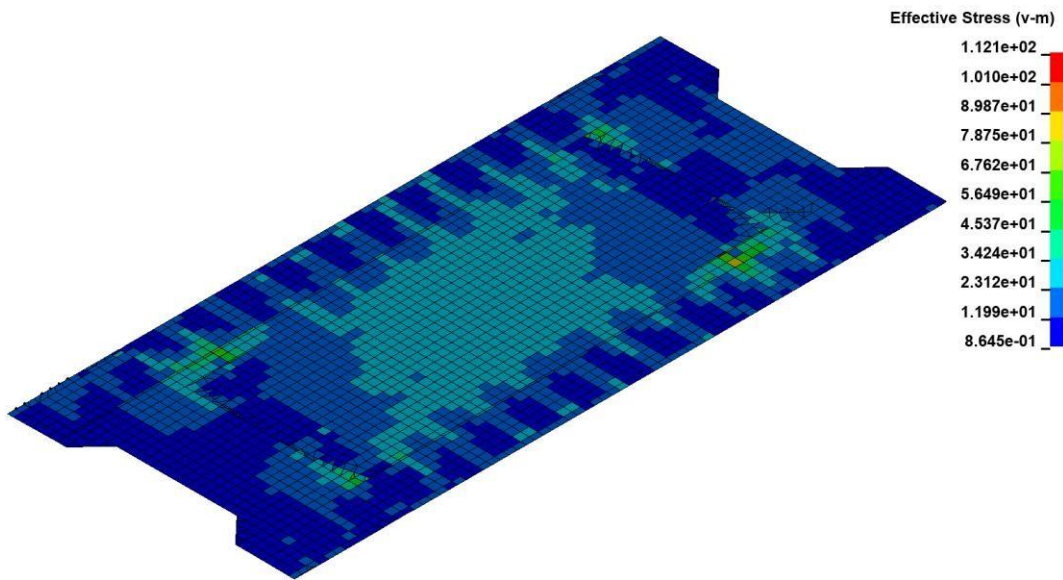
**Figure 133** Von Mises stress for structure below Main deck and between Fr35 and aft end



**Figure 134** Von Mises stress for transverse bulkhead on the Fr35

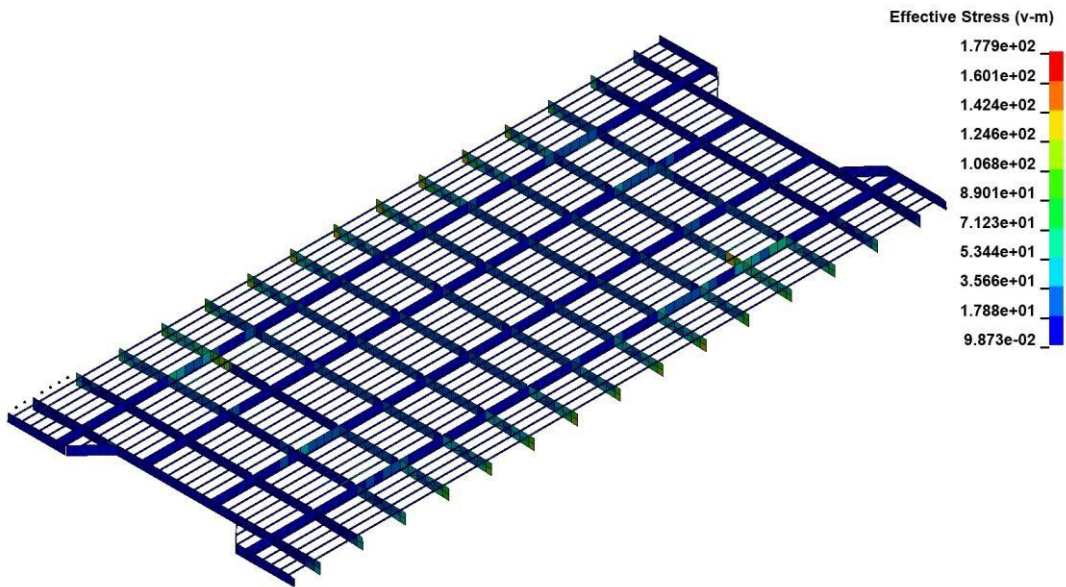


**Figure 135** Von Mises stress for transverse bulkhead on the Fr50

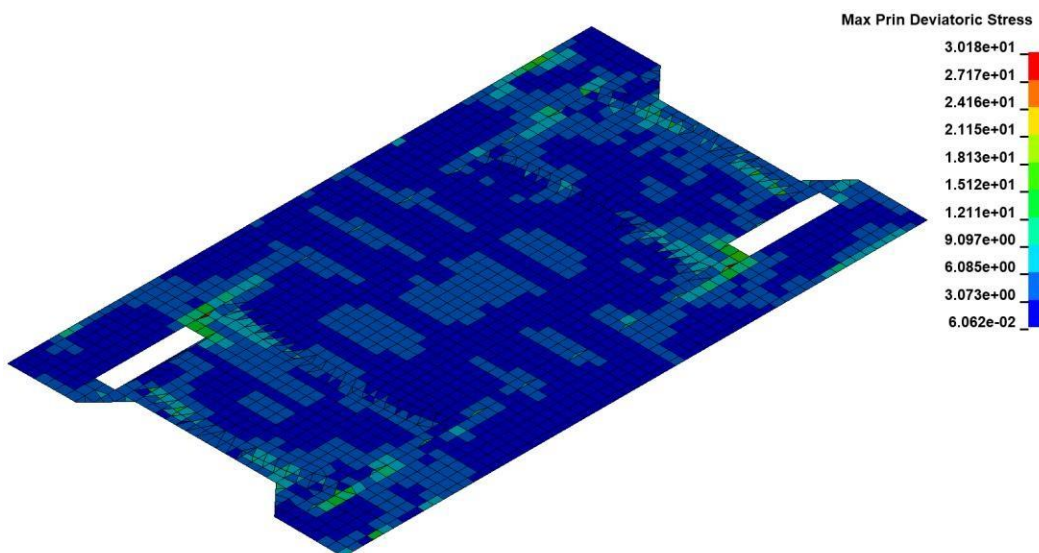


**Figure 136** Von Mises stress for Passenger deck



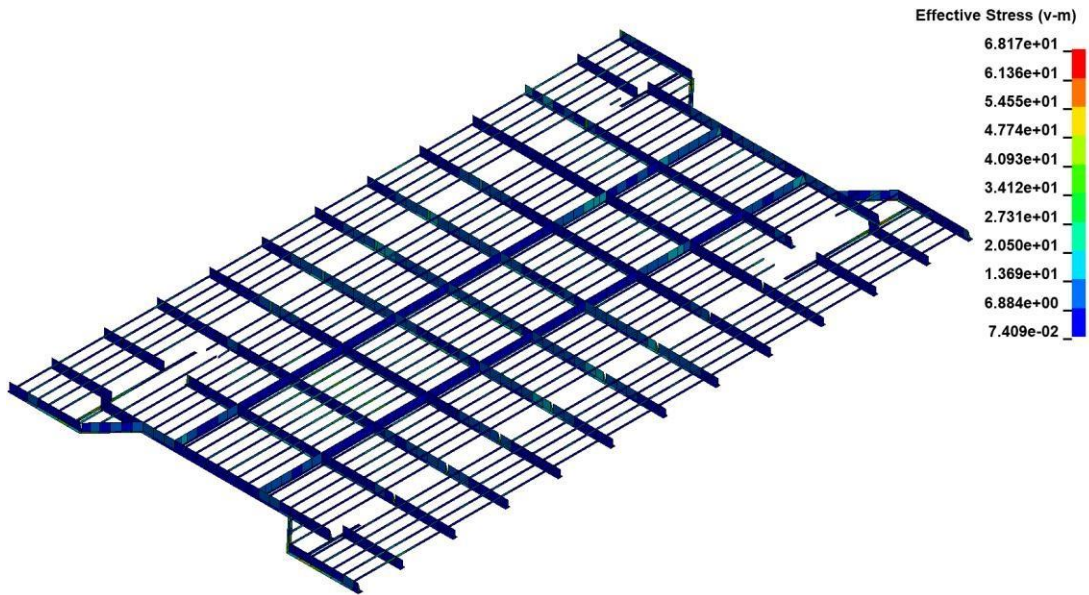


**Figure 137** Von Mises stress for structure below Passenger deck

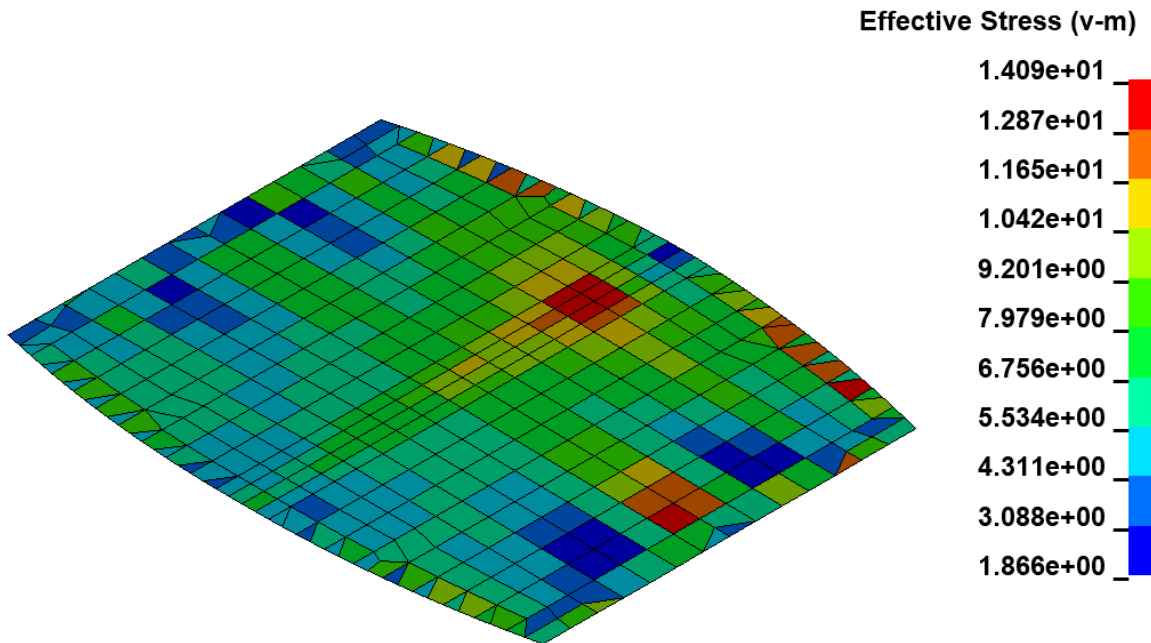


**Figure 138** Von Mises stress for Sun deck

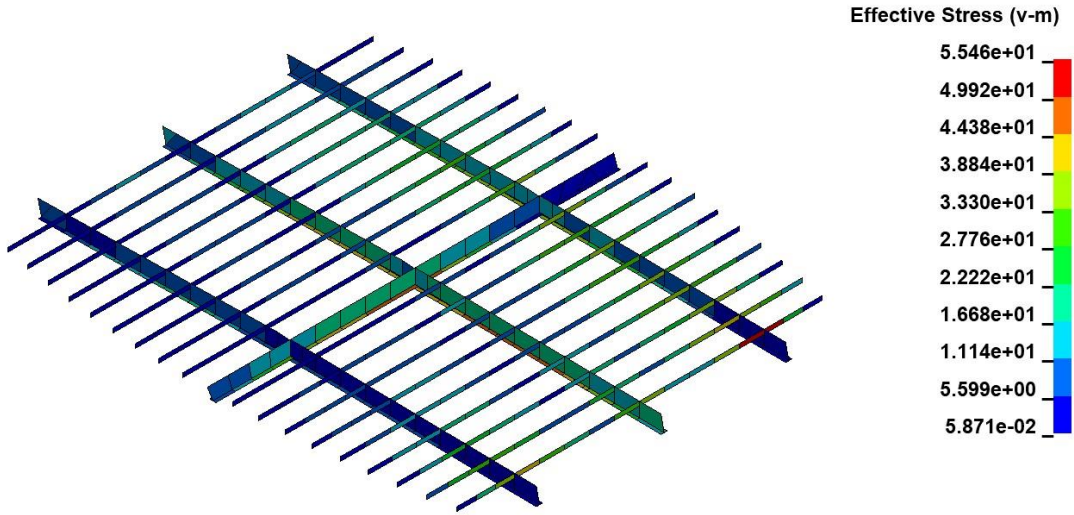




**Figure 139** Von Mises stress for structure below Sun deck

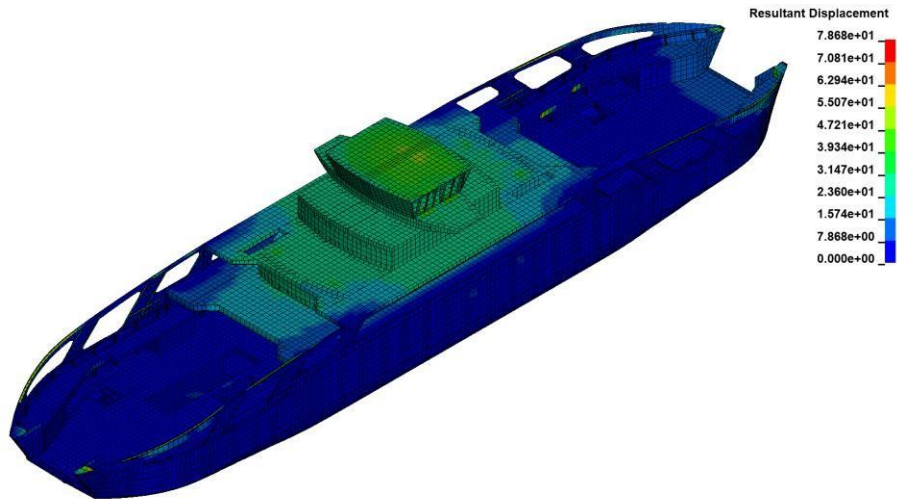


**Figure 140** Von Mises stress for Wheelhouse deck

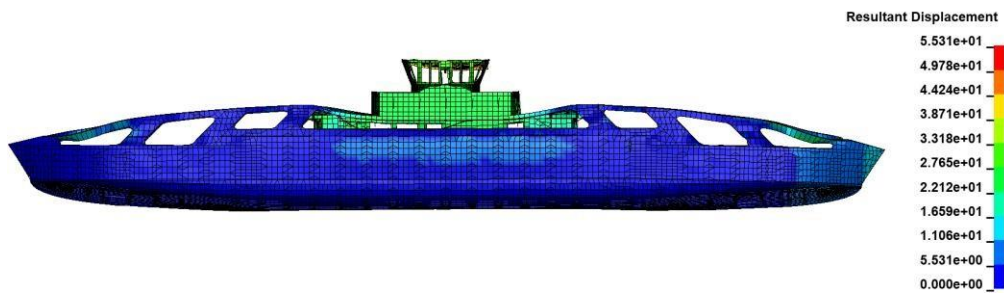


**Figure 141** Von Mises stress for structure below Wheelhouse deck

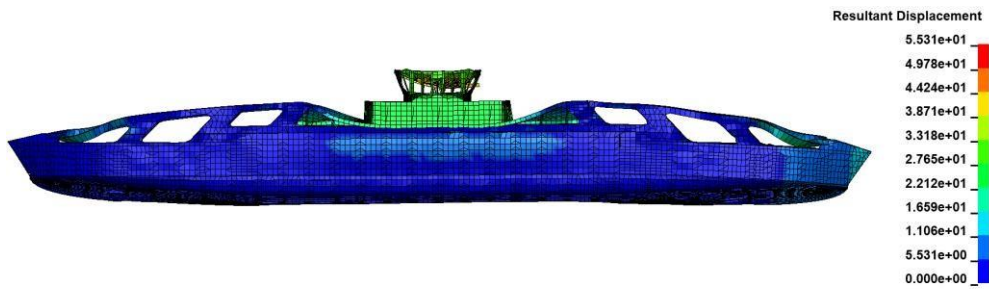
**3.5.8. Simulation 3.2.**



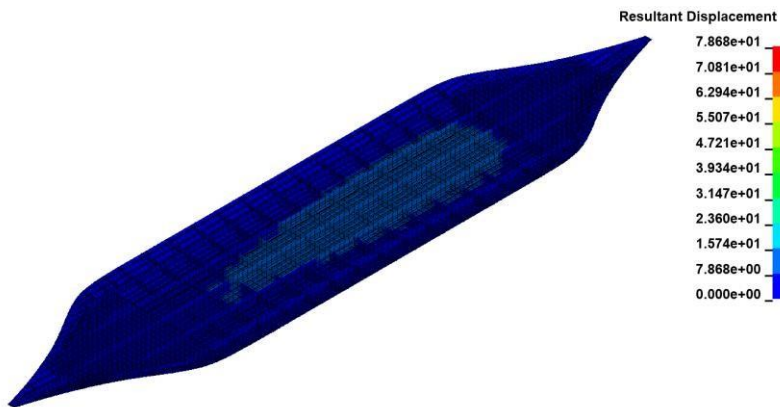
**Figure 142** *Global isometric view of resultant displacement*



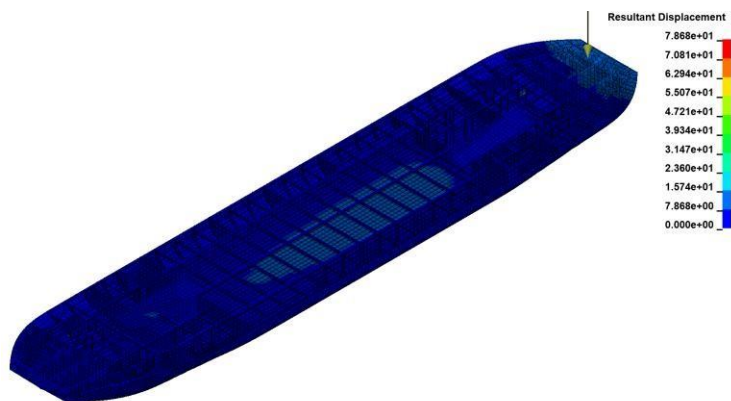
**Figure 143** *Global side view of resultant displacement scaled by 50*



**Figure 144** Global side view of resultant displacement scaled by 100

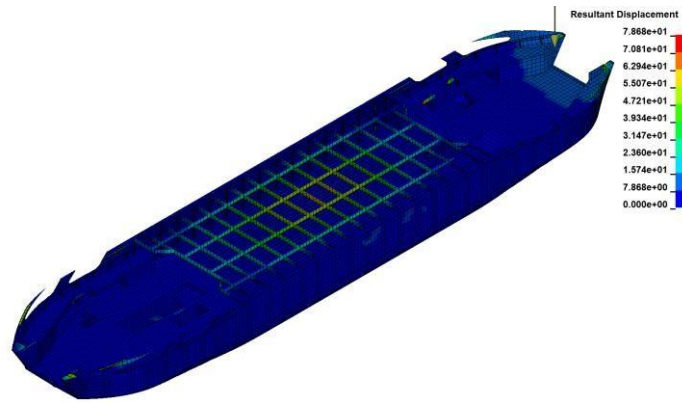


**Figure 145** Global isometric section view of resultant displacement up to the Tank top

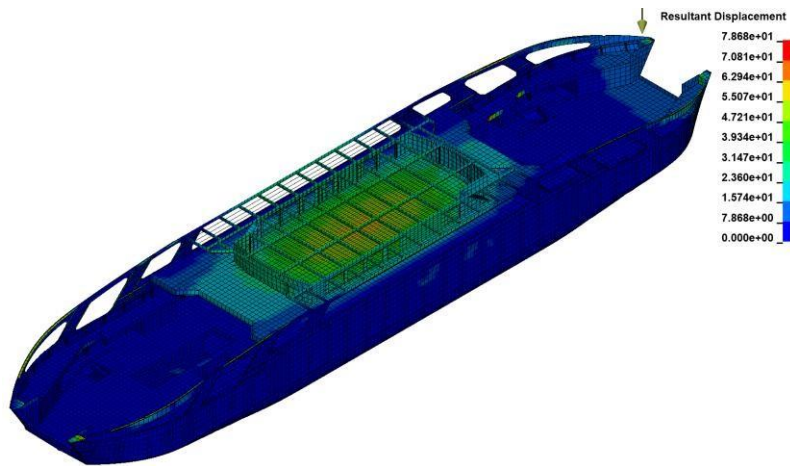


**Figure 146** Global isometric section view of resultant displacement up to the Main deck

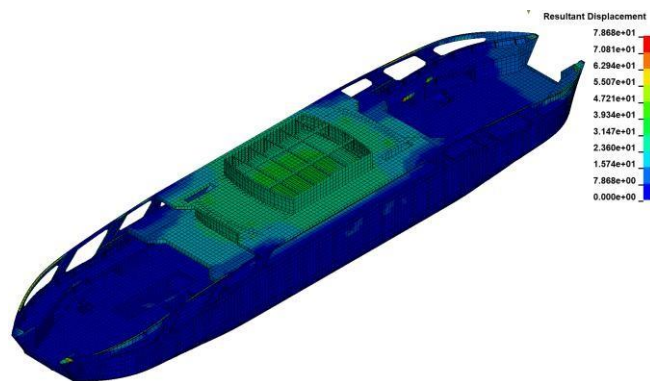




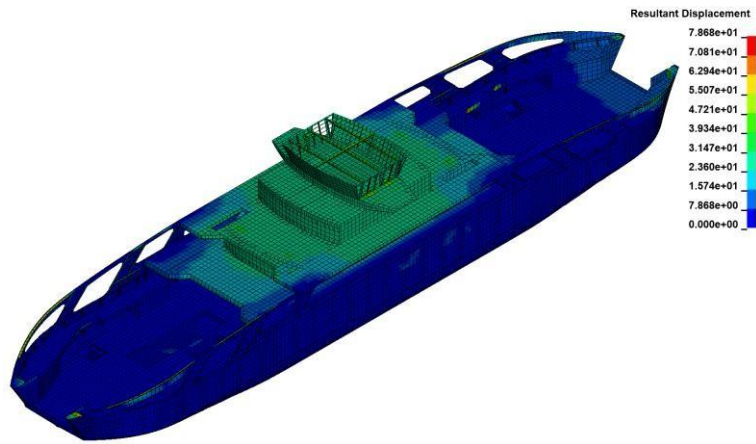
**Figure 147** Global isometric section view of resultant displacement up to the Passenger deck



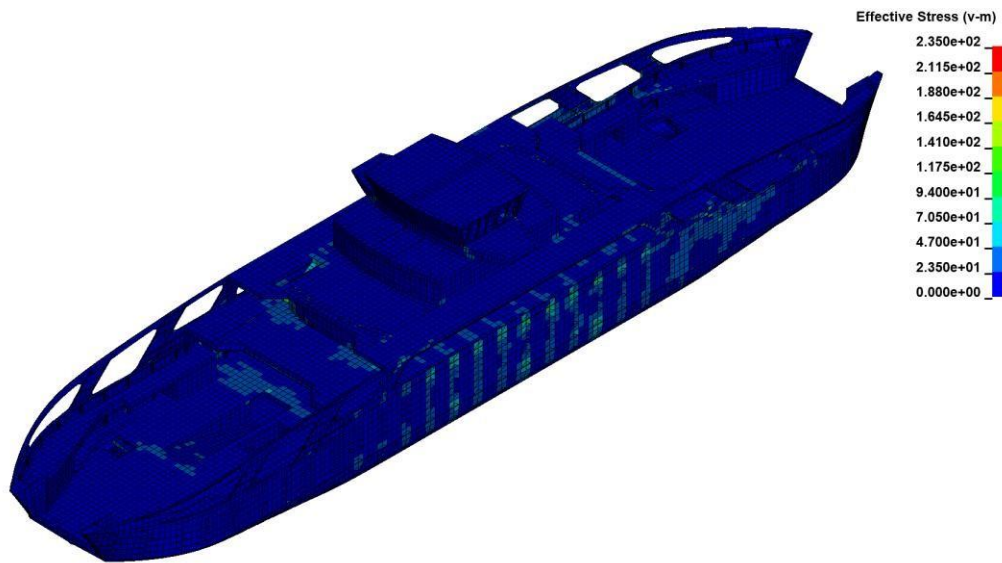
**Figure 148** Global isometric section view of resultant displacement up to the Sun deck



**Figure 149** Global isometric section view of resultant displacement up to the Superstructure top



**Figure 150** *Global isometric section view of resultant displacement up to the Wheelhouse top*



**Figure 151** *Von Mises stress global model*

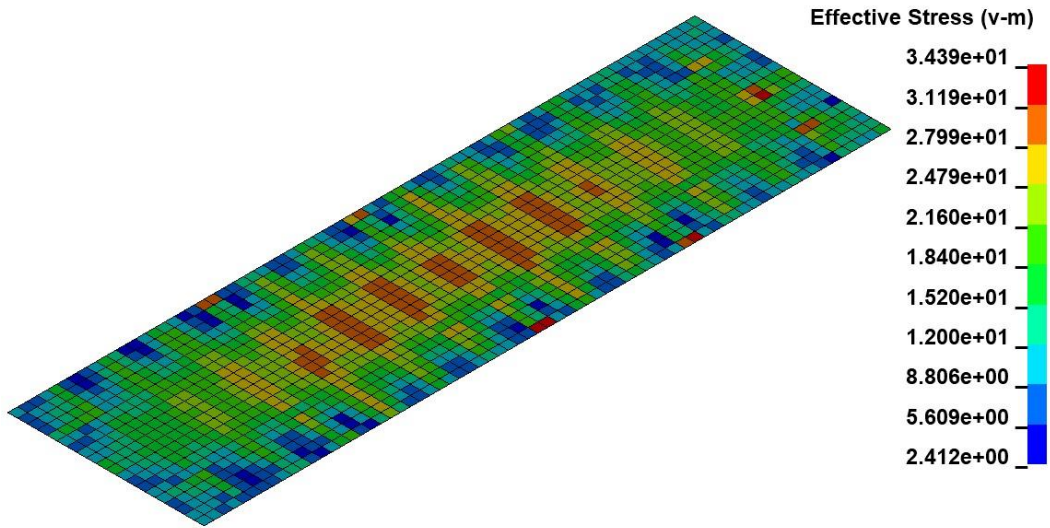


Figure 152 Von Mises stress for Tank top

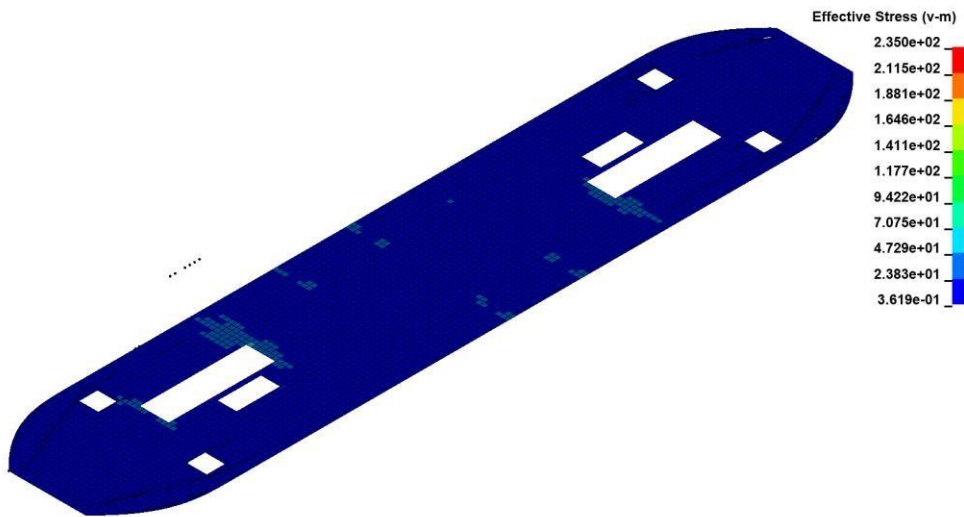
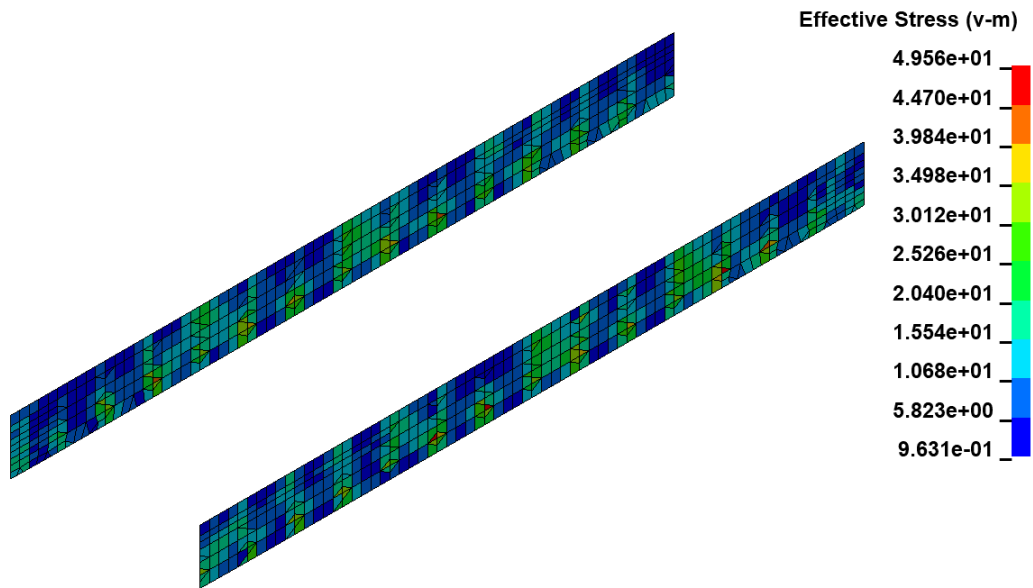
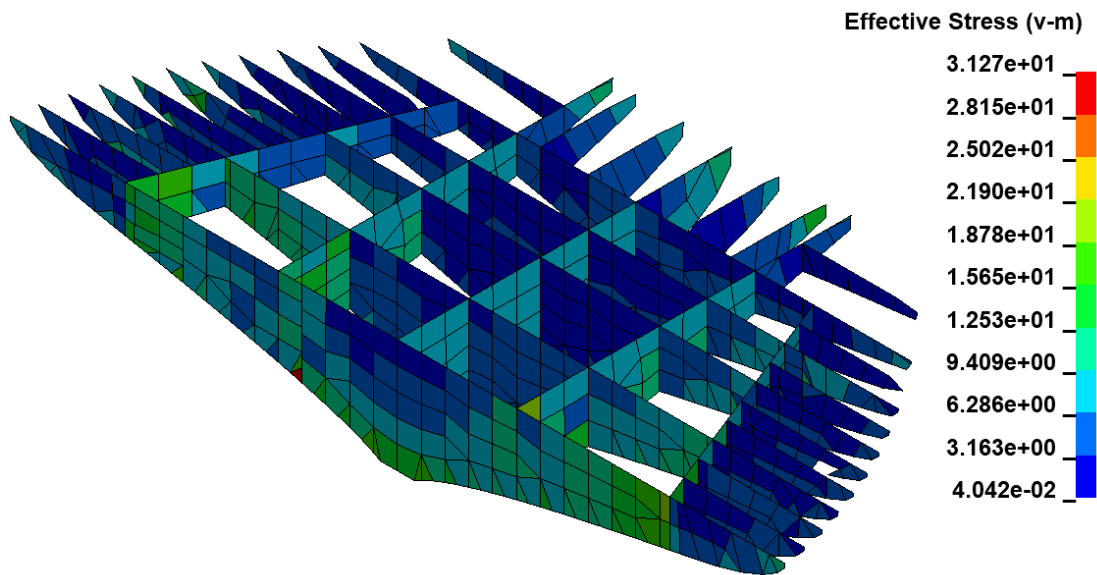


Figure 153 Von Mises stress for Main deck



**Figure 154** Longitudinal bulkhead below Main deck on  $y = \pm 5800$



**Figure 155** Von Mises stress for structure below Main deck and between Fr50 and aft end (without stiffeners)



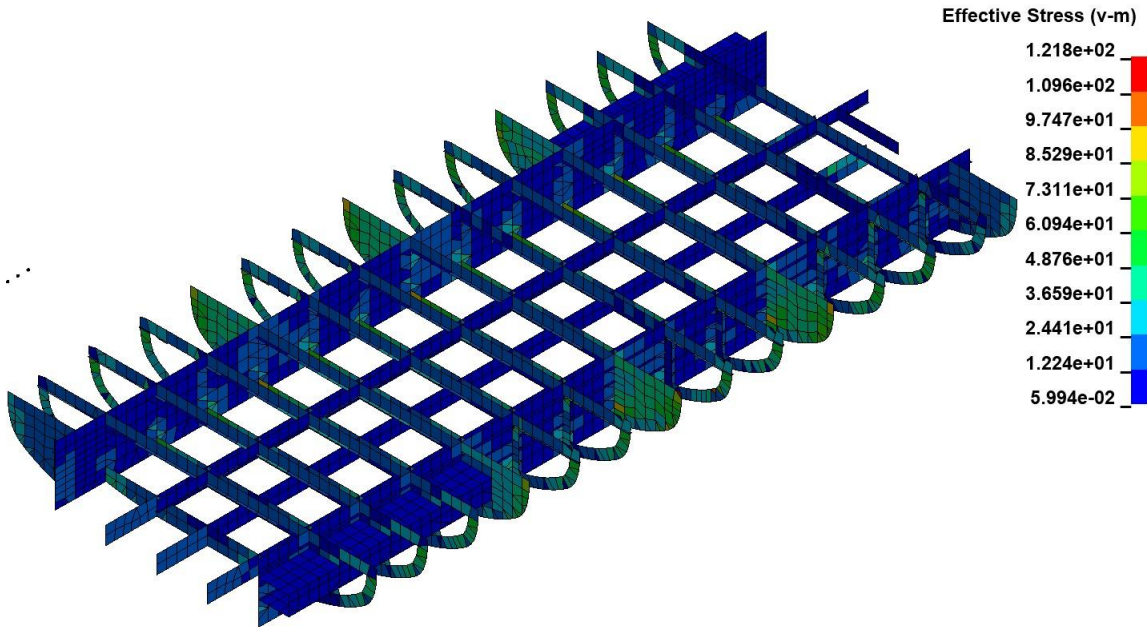


Figure 156 Von Mises stress for structure between Fr35 – Fr-35 and below Tank top

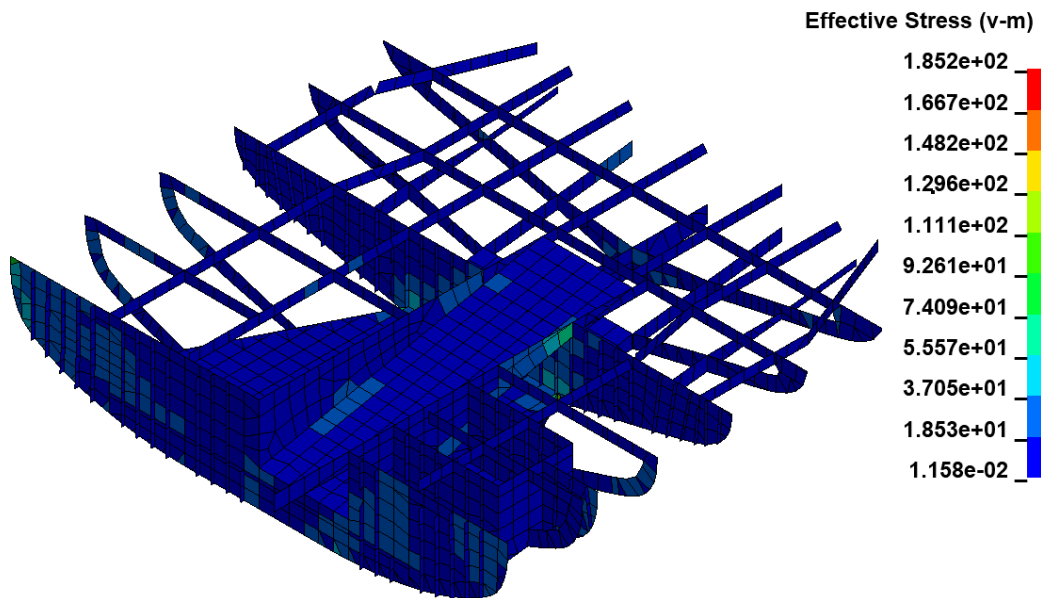
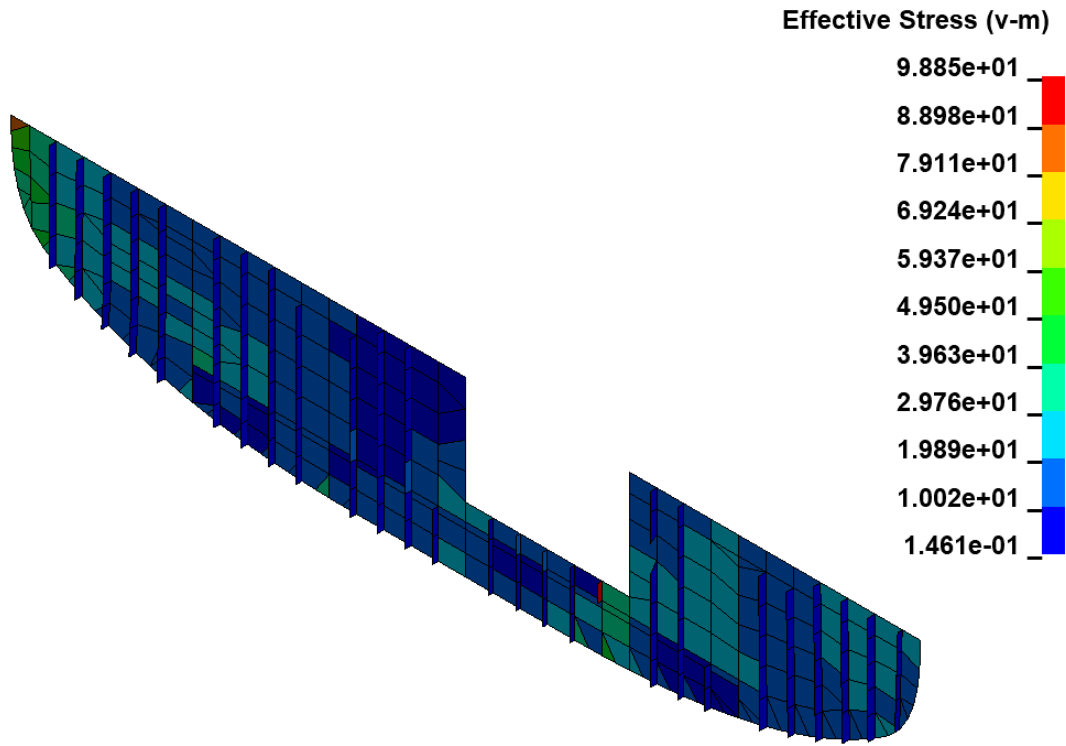
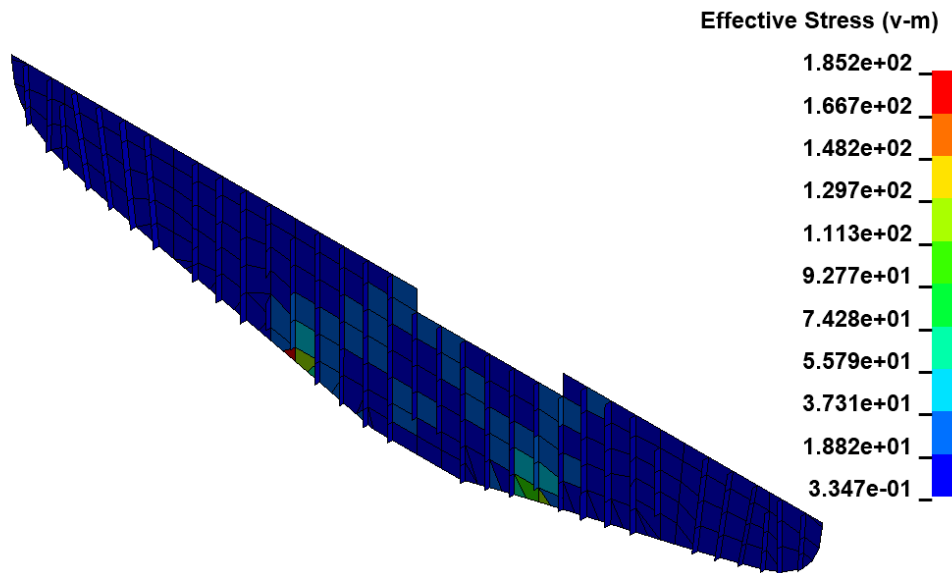


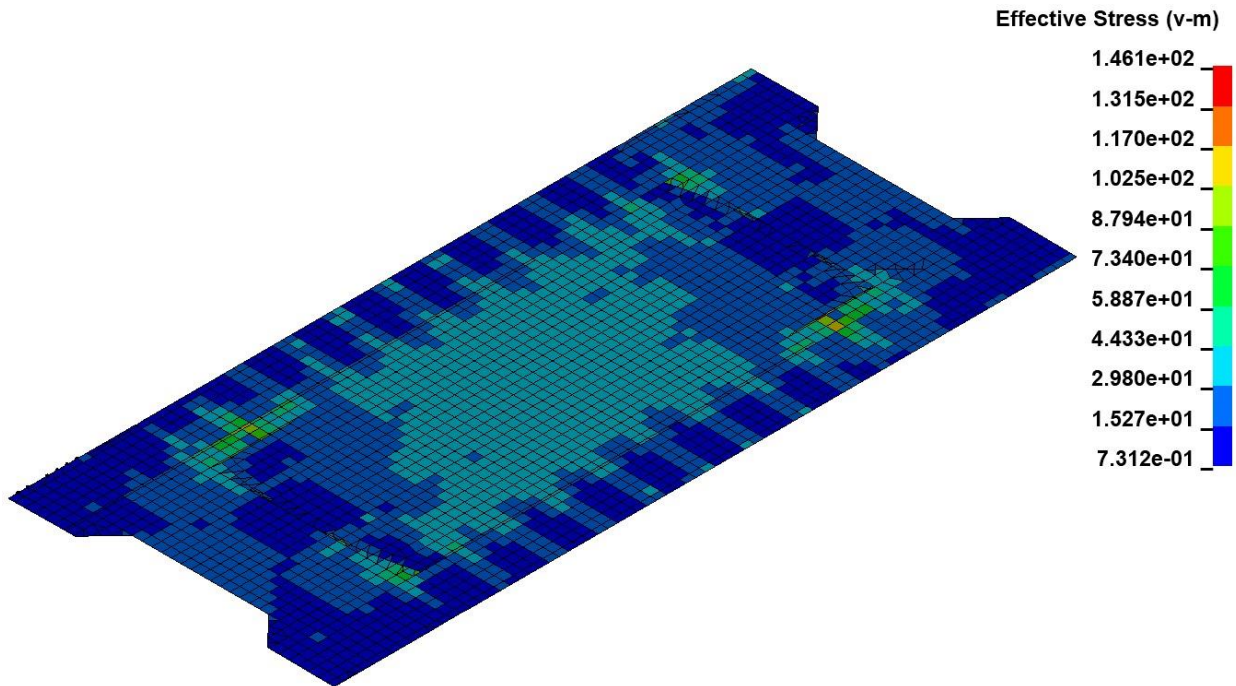
Figure 157 Von Mises stress for structure below Main deck and between Fr35 and aft end



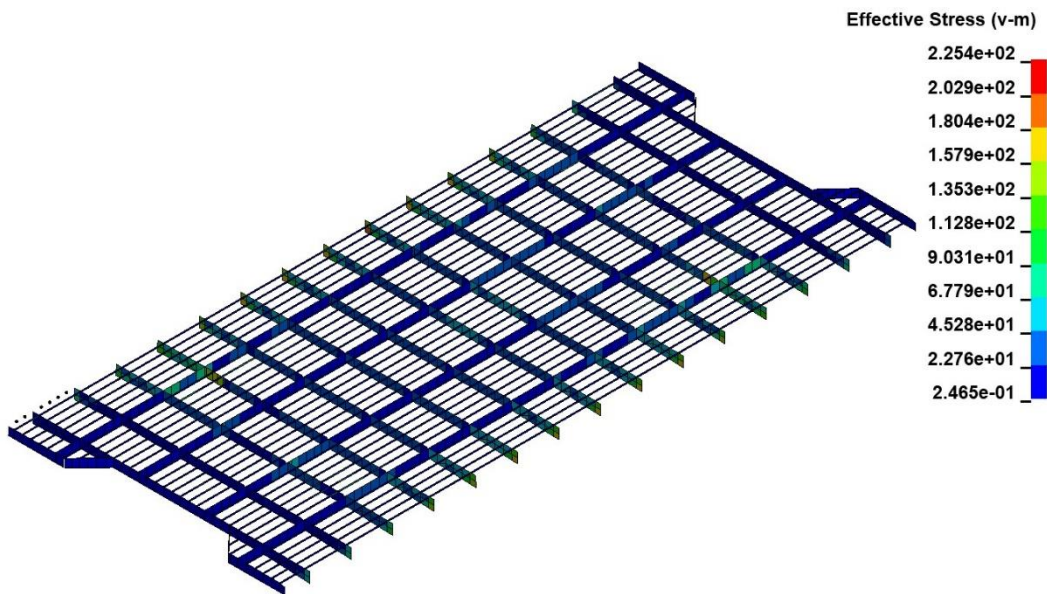
**Figure 158** Von Mises stress for transverse bulkhead on the Fr35



**Figure 159** Von Mises stress for transverse bulkhead on the Fr50



**Figure 160** Von Mises stress for Passenger deck



**Figure 161** Von Mises stress for structure below Passenger deck

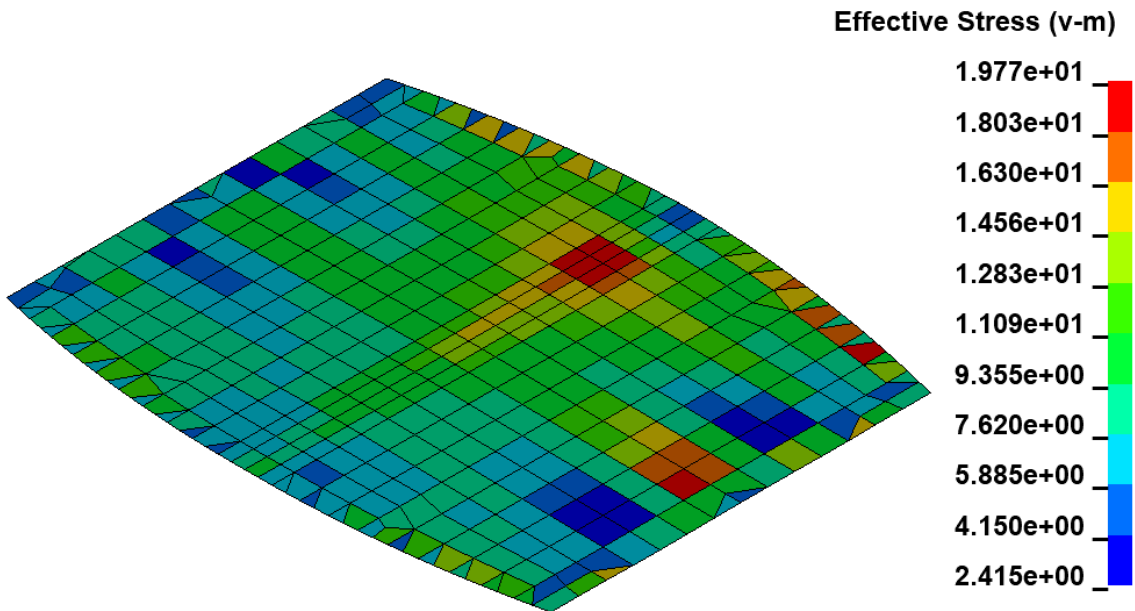


Figure 162 Von Mises stress for Wheelhouse deck

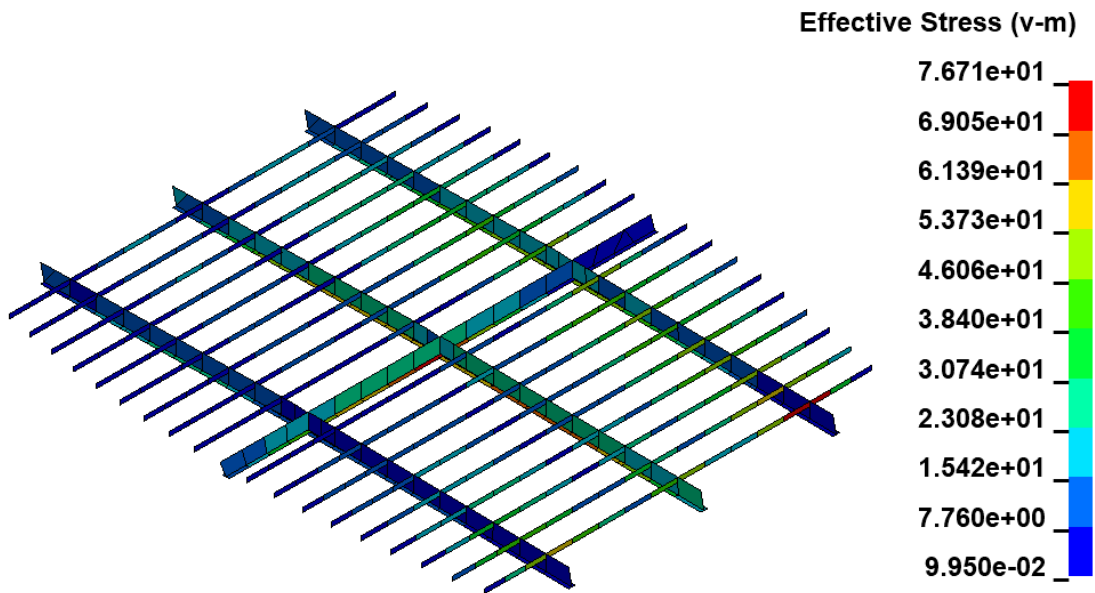


Figure 163 Von Mises stress for structure below Wheelhouse deck



### 3.5.9. Simulation 3.3.

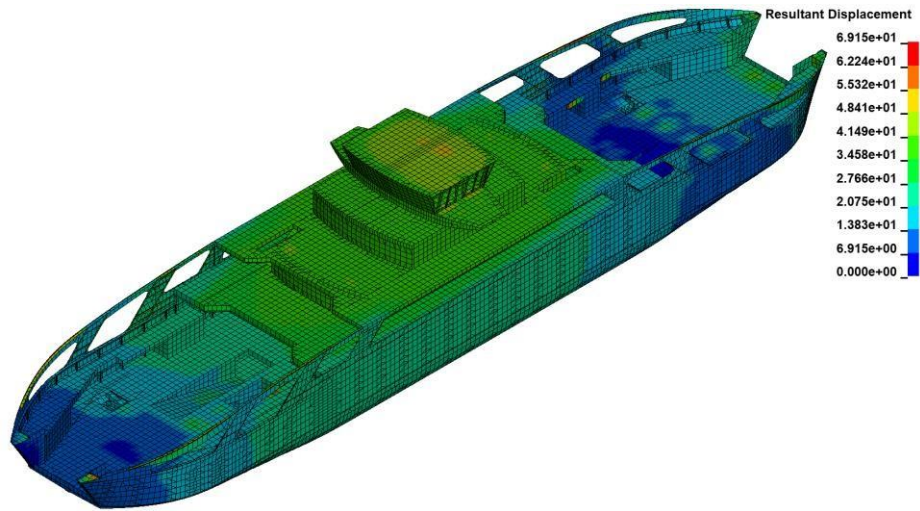


Figure 164 Global isometric view of resultant displacement

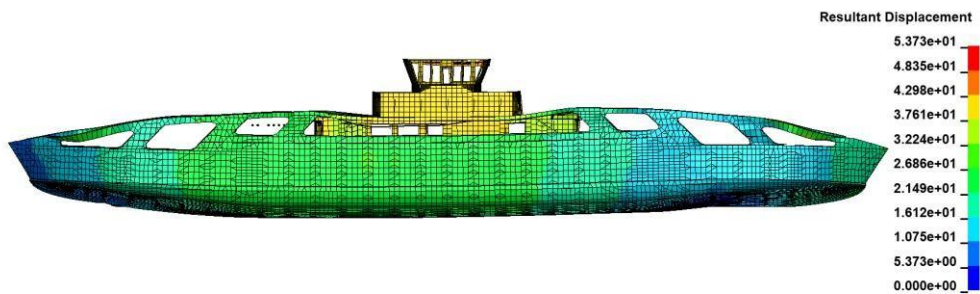


Figure 165 Global side view of resultant displacement scaled by 50

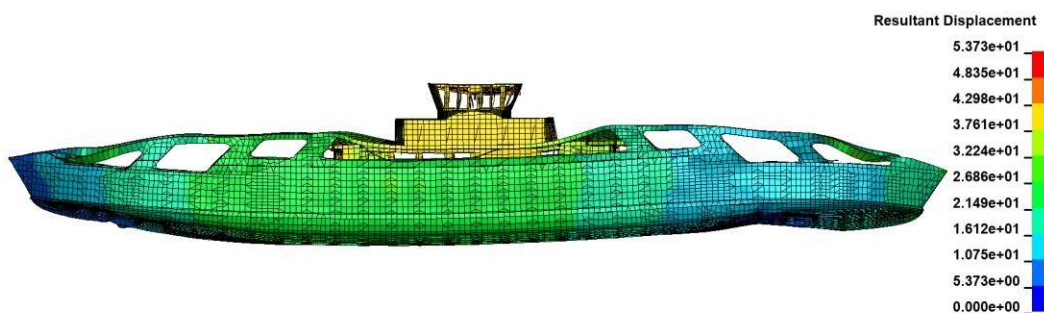
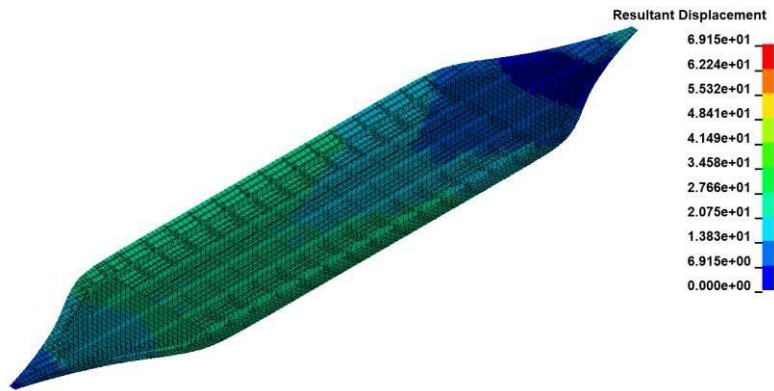
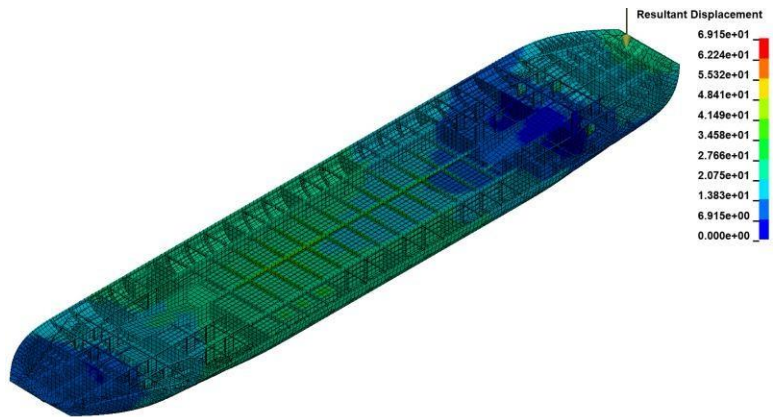


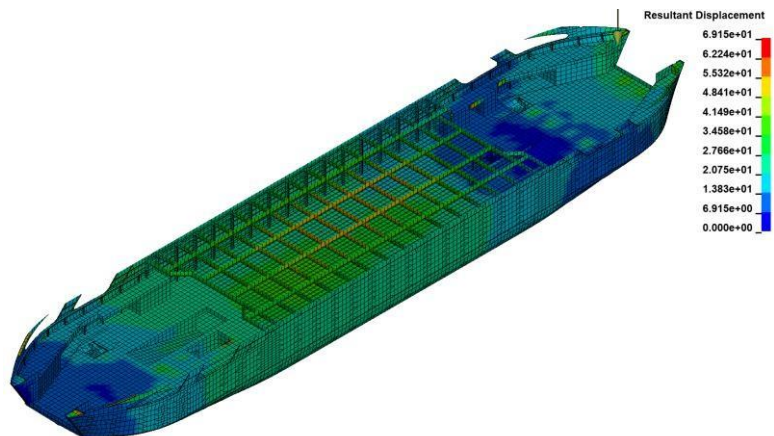
Figure 166 Global isometric side view of resultant displacement scaled by 100



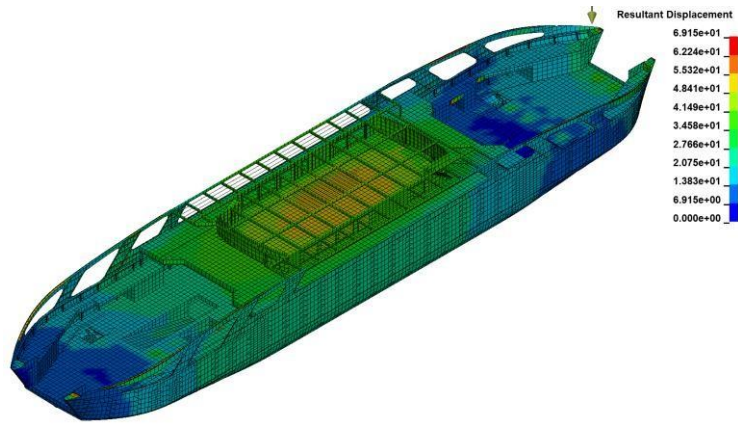
**Figure 167** *Global isometric section view of resultant displacement up to the Tank top*



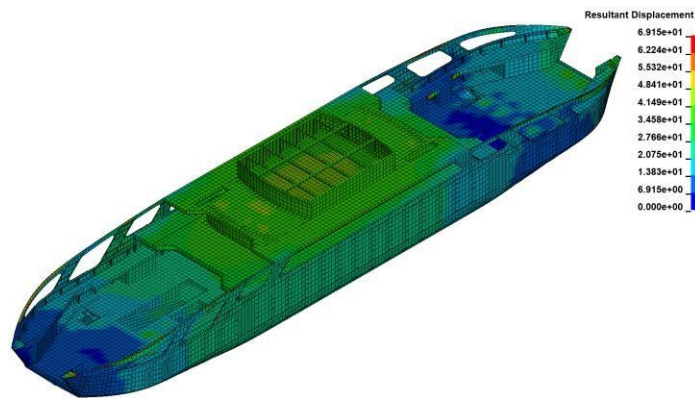
**Figure 168** *Global isometric section view of resultant displacement up to the Main deck*



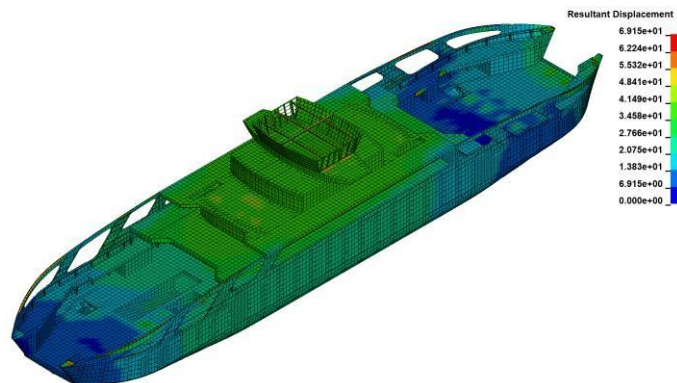
**Figure 169** *Global section isometric view of resultant displacement up to the Passenger deck*



**Figure 170** *Global isometric section view of resultant displacement up to the Sun deck*

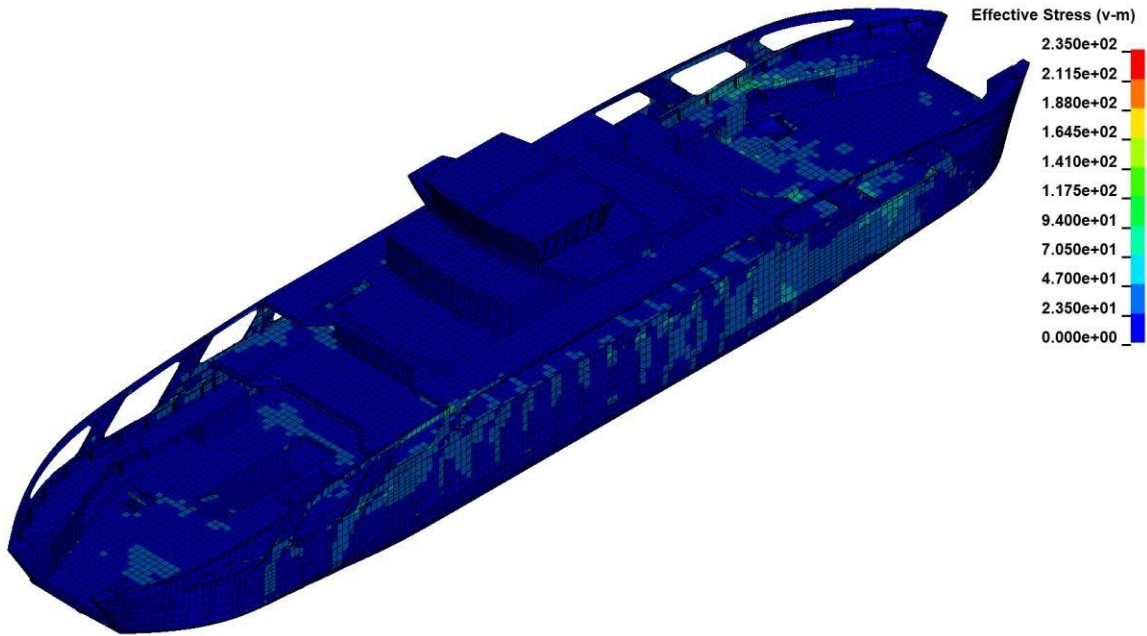


**Figure 171** *Global isometric section view of resultant displacement up to the Superstructure top*

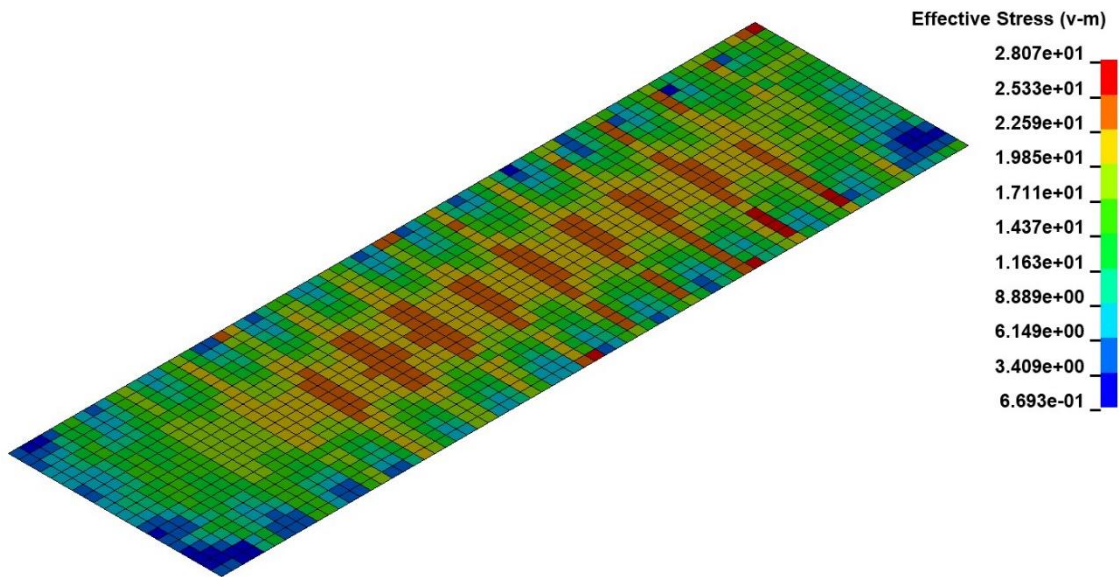


**Figure 172** *Global isometric section view of resultant displacement up to the Wheelhouse top*



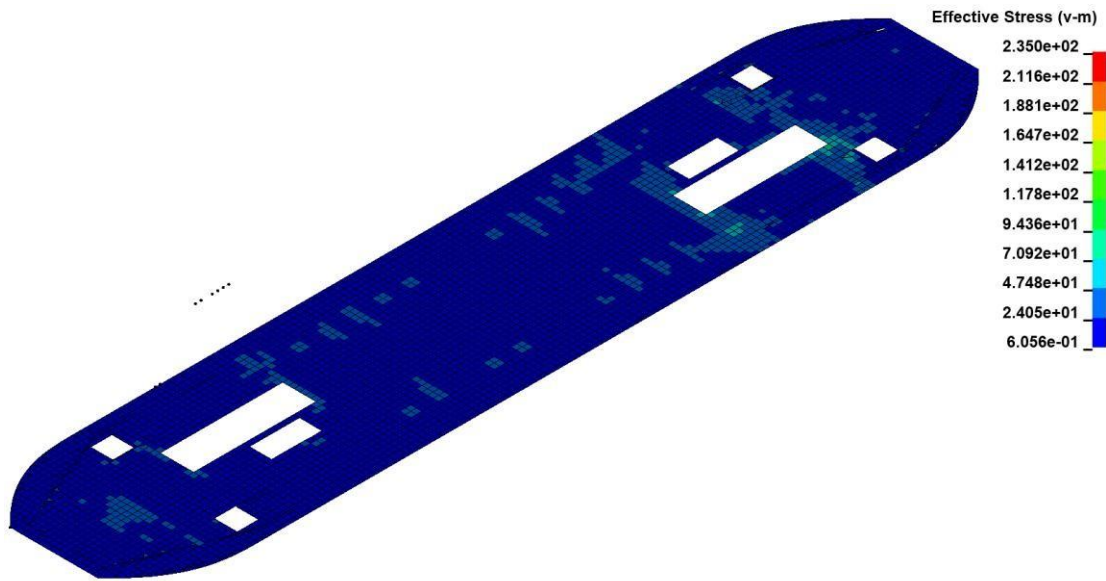


**Figure 173** Von Mises stress for global model

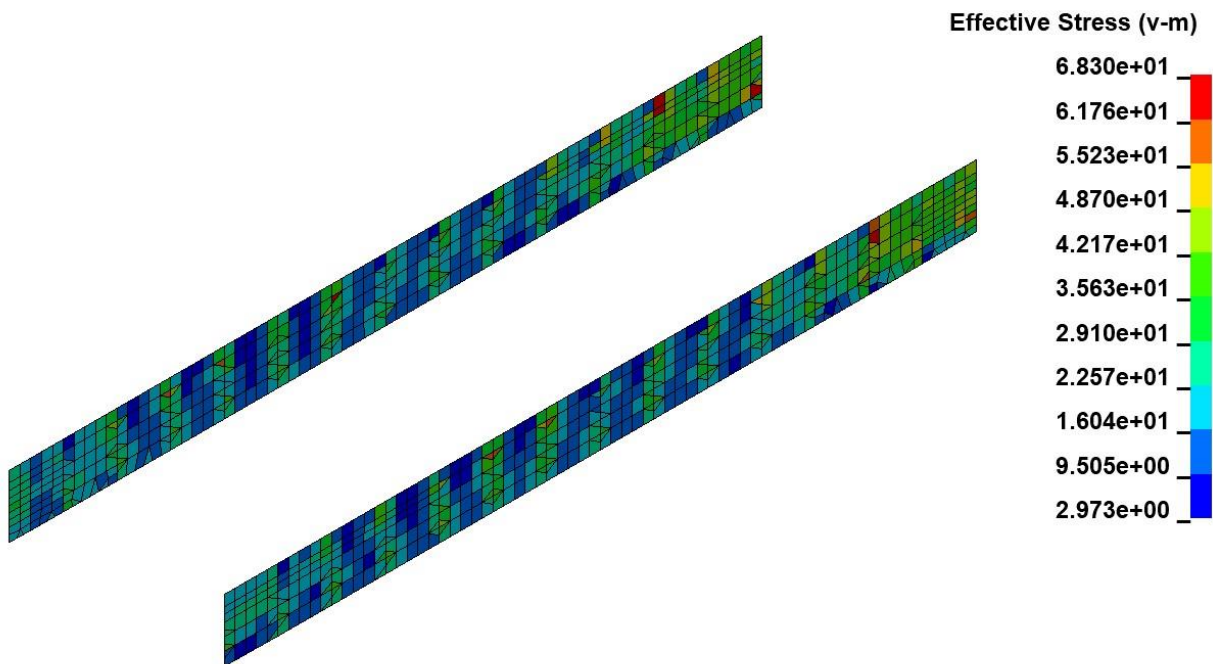


**Figure 174** Von Mises stress for Tank top

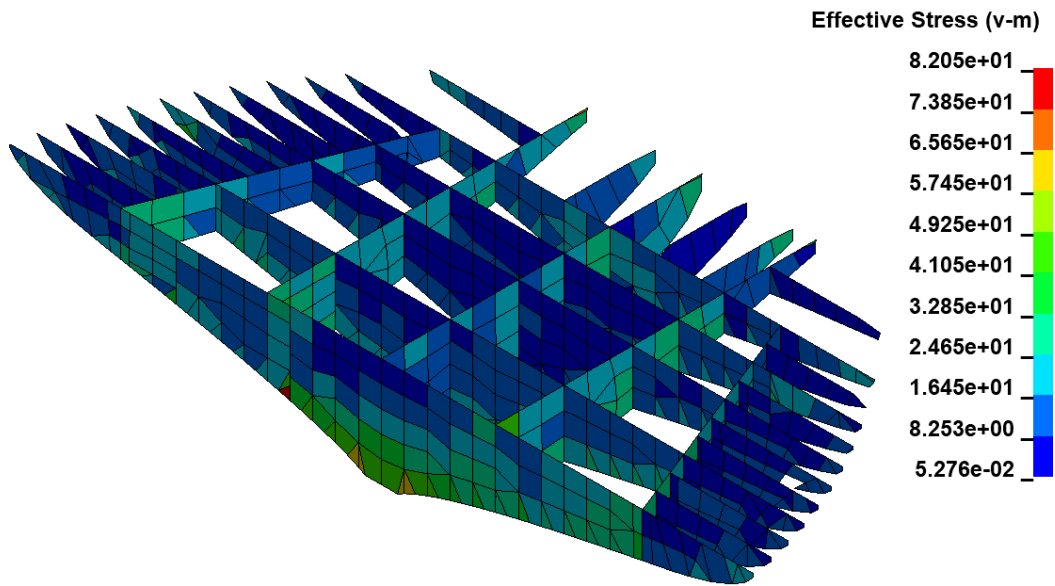




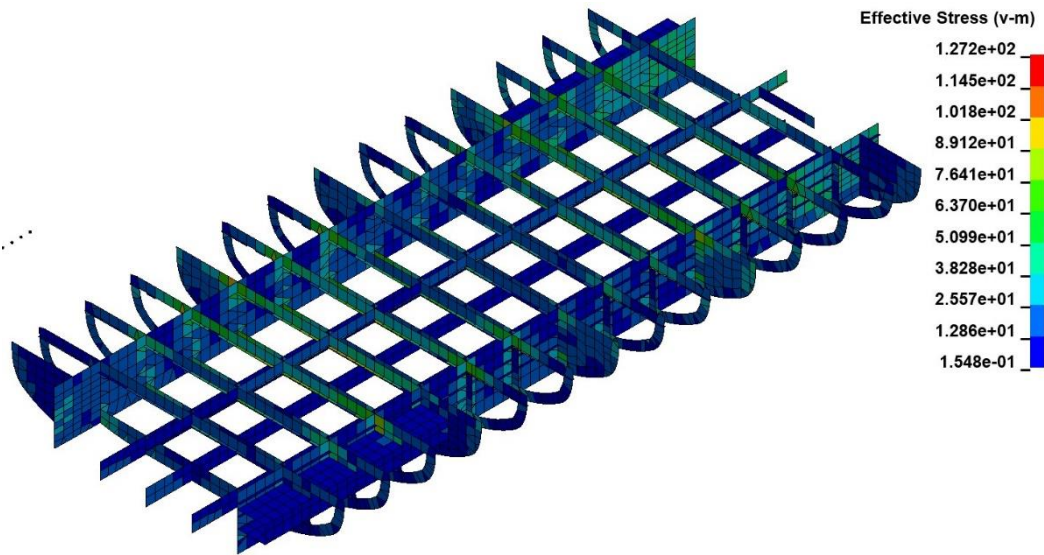
**Figure 175** Von Mises stress for Main deck



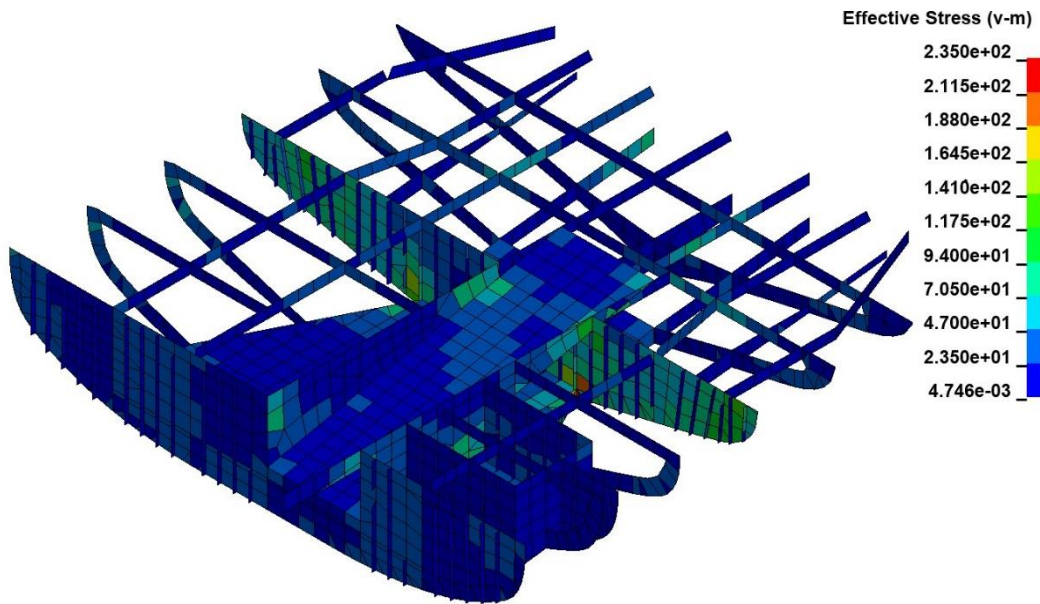
**Figure 176** Longitudinal bulkhead below Main deck on  $y = \pm 5800$



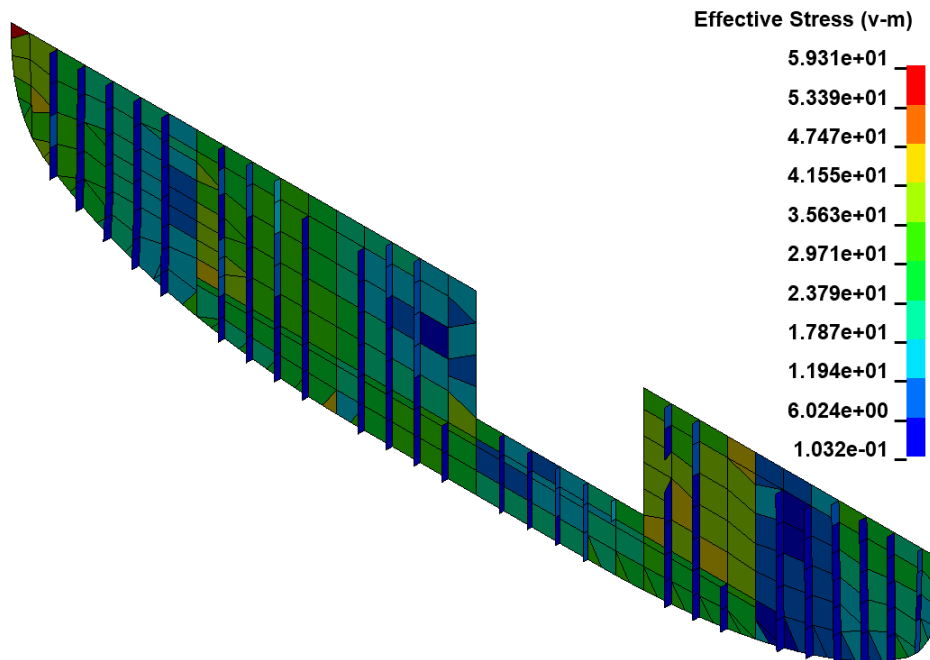
**Figure 177** Von Mises stress for structure below Main deck and between Fr50 and aft end (without stiffeners)



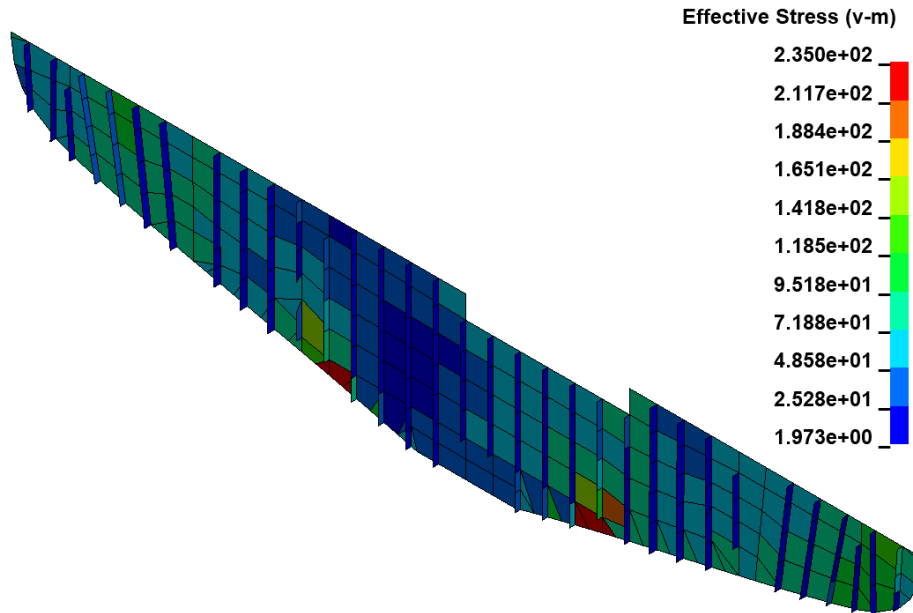
**Figure 178** Von Mises stress for structure between Fr35 – Fr-35 and below Tank top



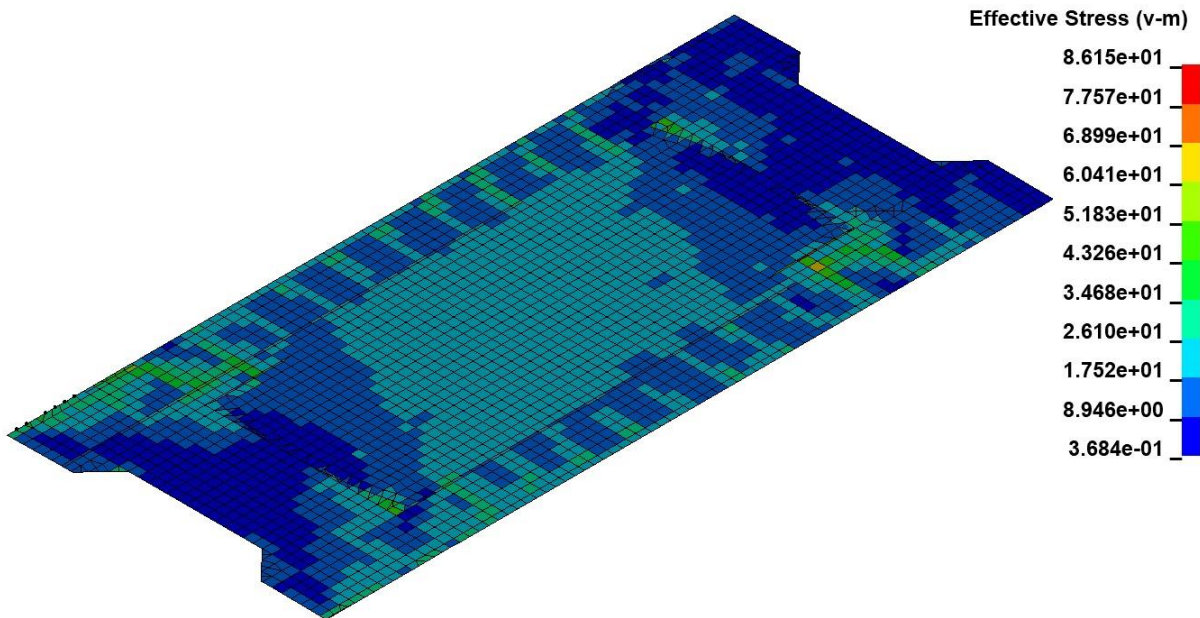
**Figure 179** Von Mises stress for structure below Main deck and between Fr35 and aft end



**Figure 180** Von Mises stress transverse bulkhead on the Fr 35

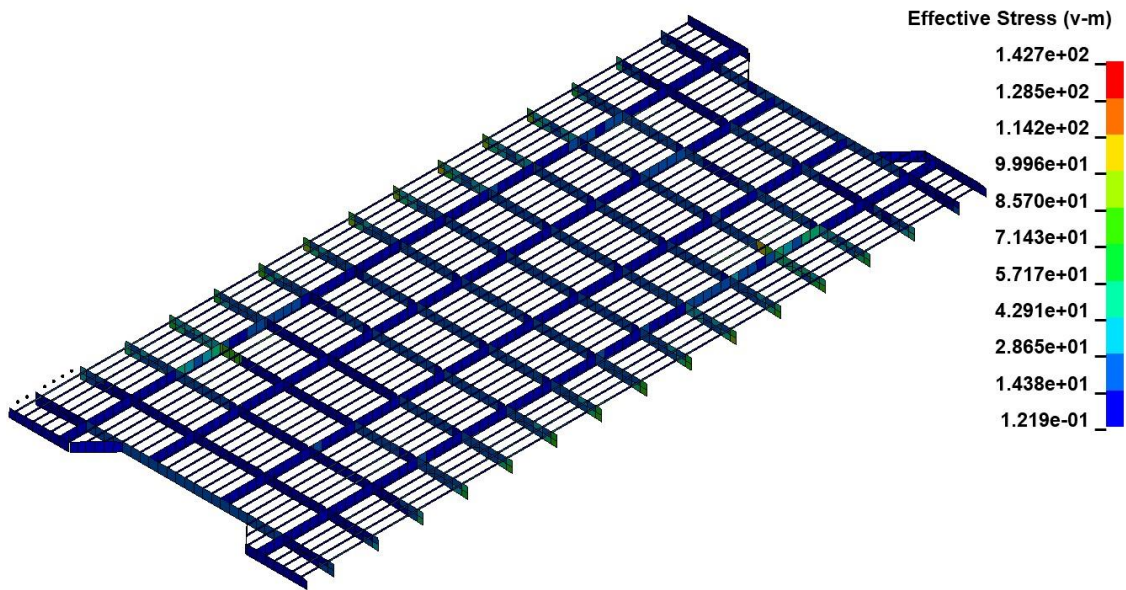


**Figure 181** Von Mises stress for transverse bulkhead on the Fr50

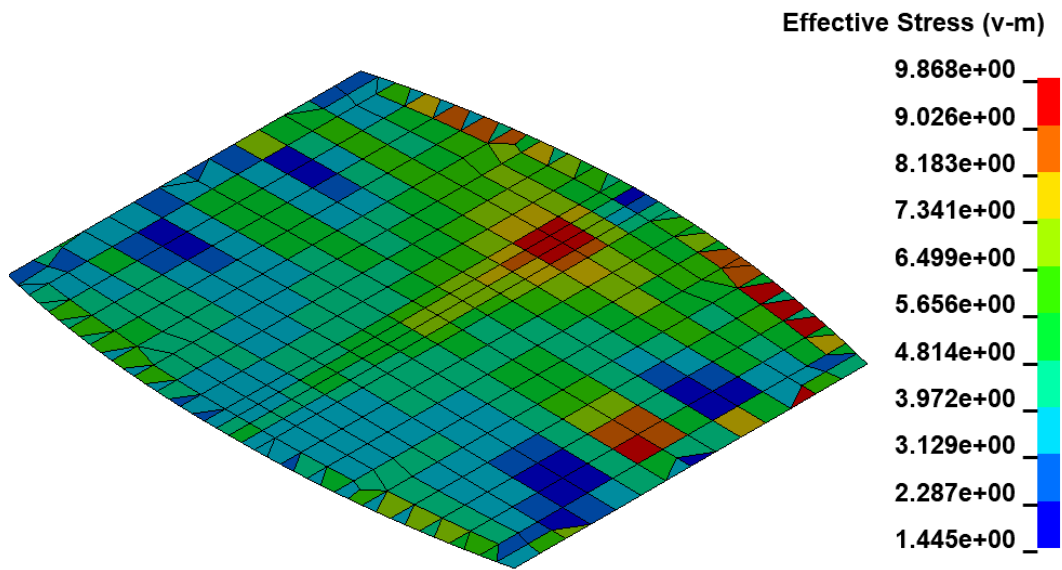


**Figure 182** Von Mises stress for Passenger deck





**Figure 183** Von Mises stress for structure below Passenger deck



**Figure 184** Von Mises stress for Wheelhouse top

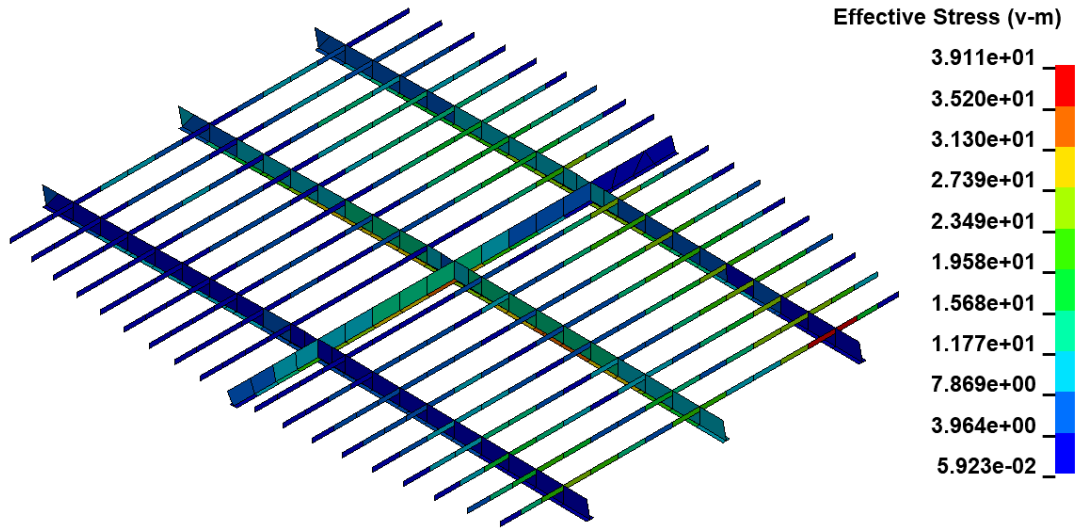
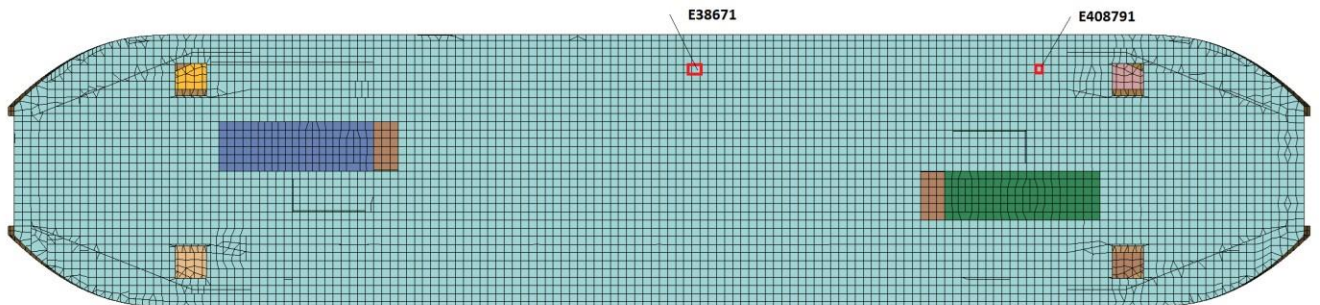


Figure 185 Von Mises stress for structure below Wheelhouse top

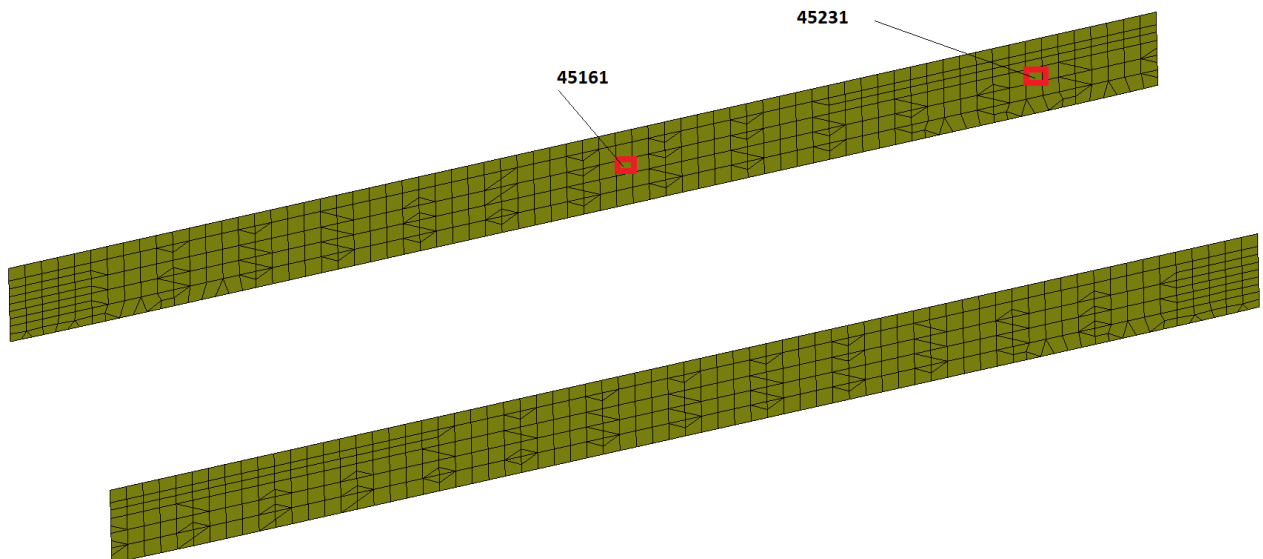
## 4. SIDE AND SUPERSTRUCTURE EFFICIENCY ANALYSIS

### 4.1. Background for comparison

To compare the stress levels for the case where the superstructure (Model 2 and Model 3) participates and does not participate (Model 1) in the longitudinal strength of the ship, two parts were chosen, the main deck, Figure 186 and the longitudinal side girder / bulkhead in the double bottom. Additionally, two elements were observed, one in the middle of the ship towards the side and the other on the bow quarter (Frame 60). For the side girder in length in the same positions and in height in the middle of the girder height, Figure 187.



**Figure 186** Main deck element position and number for strength comparison for different models



**Figure 187** Longitudinal bulkhead below Main deck on  $y = \pm 5800$ ; element position and number for strength comparison for different models

## 4.2. Structural elements strength comparison

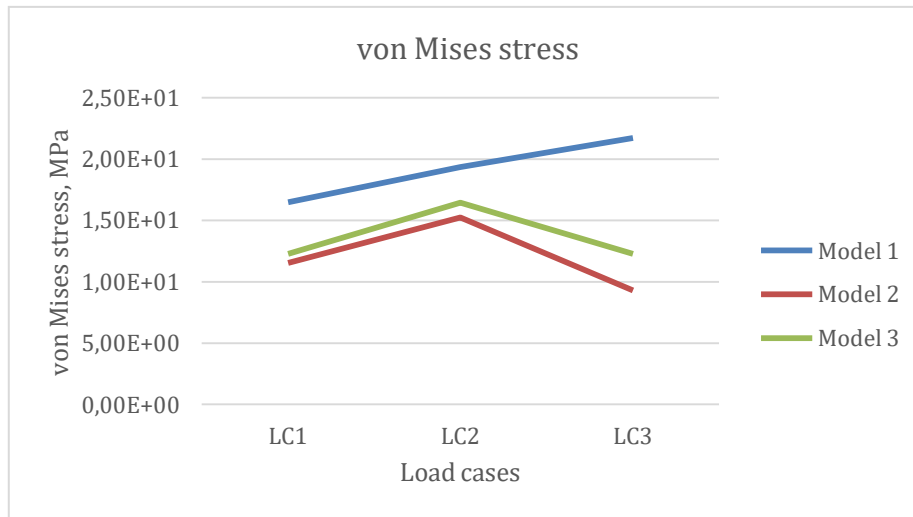
For main deck elements, stress values (in MPa) for all three loading cases and all three different models are shown in Tables 16 and 17, and in Figures 188 and 189.

**Table 16** Von Mises stress for element E38671

	LC1	LC2	LC3
<b>Model 1</b>	1.65E+01	1.93E+01	2.17E+01
<b>Model 2</b>	1.15E+01	1.53E+01	9.30E+00
<b>Model 3</b>	1.23E+01	1.64E+01	1.23E+01

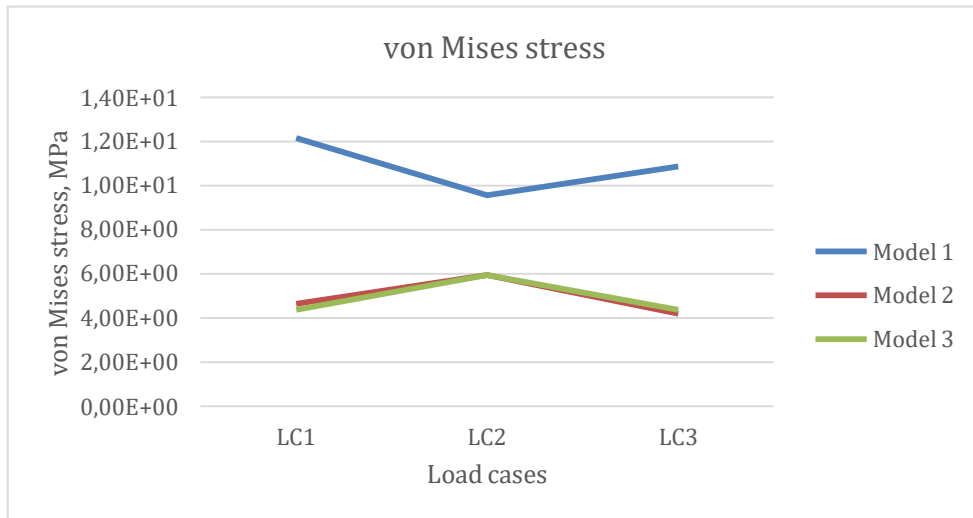
**Table 17** Von Mises stress for element E408791

	LC1	LC2	LC3
<b>Model 1</b>	1.21E+01	9.56E+00	1.09E+01
<b>Model 2</b>	4.65E+00	5.95E+00	4.20E+00
<b>Model 3</b>	4.37E+00	5.95E+00	4.37E+00



**Figure 188** Element on Main deck (E38671) von Mises stress for all three load cases





**Figure 189** Element on Main deck (E408791) von Mises stress for all three load cases

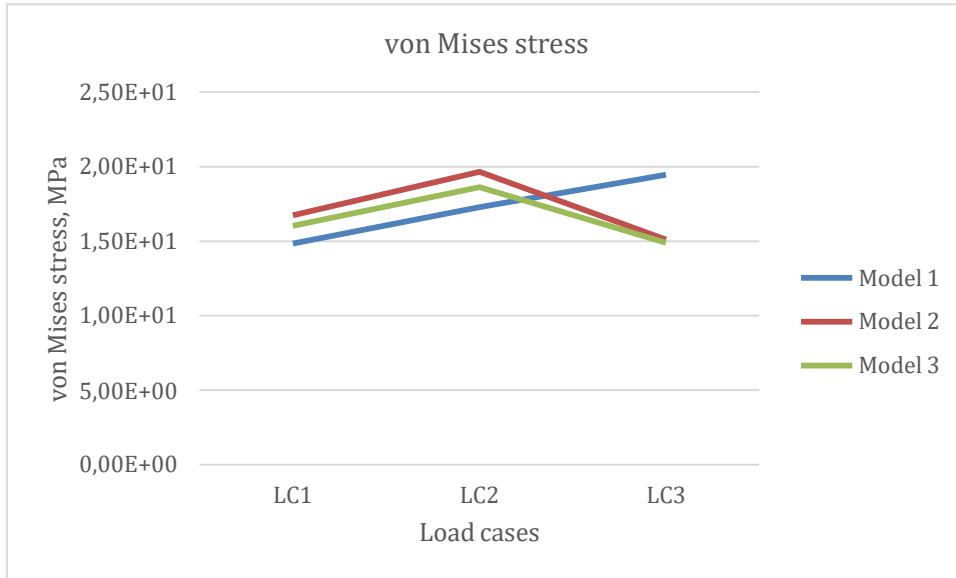
For longitudinal side girder / bulkhead elements, stress values (in MPa) for all three loading cases and all three different models are shown in Tables 18 and 19, and on Figures 190 and 191.

**Table 18** Von Mises stress for element 45161

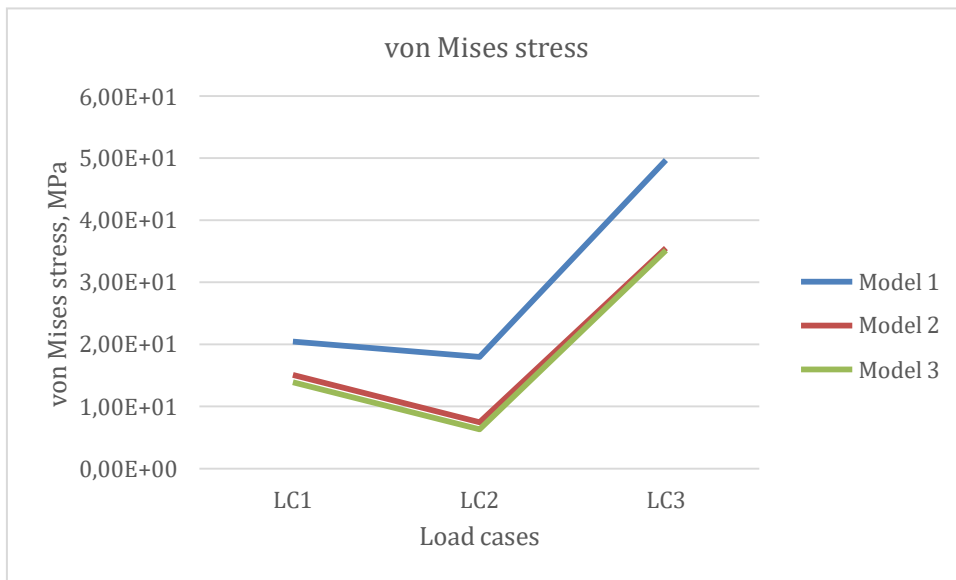
	LC1	LC2	LC3
<b>Model 1</b>	1.48E+01	1.73E+01	1.95E+01
<b>Model 2</b>	1.67E+01	1.96E+01	1.51E+01
<b>Model 3</b>	1.60E+01	1.86E+01	1.49E+01

**Table 19** Von Mises stress for element 45231

	LC1	LC2	LC3
<b>Model 1</b>	2.04E+01	1.80E+01	4.97E+01
<b>Model 2</b>	1.51E+01	7.47E+00	3.55E+01
<b>Model 3</b>	1.39E+01	6.31E+00	3.51E+01



**Figure 190** Element on Longitudinal bulkhead (E45161) von Mises stress for all three load cases



**Figure 191** Element on Longitudinal bulkhead (E45231) von Mises stress for all three load cases

## 5. CONCLUSION

In order to check and validate the global strength of the Ro-Pax ferry hull structure through FEA, scantlings are determined in accordance to BV rules. Three level of the structural model are produced in order to estimate the efficiency of the superstructure in the longitudinal strength. Models are meshed and three load cases are considered as most unfavourable ones from trim and stability book regard to maximum vertical bending moment. These leads to nine different calculation run. Results, in form of displacement and stresses are presented in detail. Static loads are modelled as much realistic as possible from load cases. It means that distribution of weight is considered and consequently the buoyancy distribution at proper water line. Additional mass of engine, equipment and other groups are considered as well as loads from the car and trucks. Stresses over the limit criteria are not observed because the hydrodynamic loads and analysis are not conducted leaving enough spaces for the wave vertical bending moment to stress limit. Main goal of the analysis is to check global strength to static load, i.e. still water bending moment, to find possible primary structural element subjected to higher stress level. Only local high stress area / elements have been found on several watertight bulkhead and wheelhouse deck plating:

Model	Load case	Structural part	Position / Frame	VM Stress, MPa	Figure
1	LC1	Bulkhead	35	170 local	34
	LC3	Bulkhead	50	235 local	64
2	LC1	Bulkhead	50	175 local	77
	LC2	Bulkhead	20	235 local	109
	LC3	Bulkhead	50	235 local	110
3	LC1	Bulkhead	50	175 local	131
	LC1	Wheelhouse	MS	140 local	136
	LC2	Wheelhouse	MS	197 local	157
	LC3	Bulkhead	50	235 local	176

As a base for further structural optimisation the second goal of the analysis was to investigate the influence of the superstructure, including side structure above main deck in the longitudinal strength. Hypothesis that the superstructure has a positive influence on longitudinal strength i.e. decreasing stress level in primary structure has proven correct. Only two type of structural elements are observed, main deck plating near side (two elements in longitudinal direction) and bottom longitudinal side girder/bulkhead (two elements in middle height) as a base for more detailed analysis for higher number of structural elements. Analysis has shown decreasing stress level with more side and superstructure included in calculation. Therefore, it would be worthy to continue with additional analysis and optimisation on further step of design spiral to include hydrodynamic calculation and to investigate much more structural elements in scantlings / weight optimisation.

## REFERENCES

- [1] Novak, L. J., Majnarić, D., Dejhalla, R., Zamarin, A.: An Analysis of Basic Parameters of Ro-Pax Ships and Double-ended Ferries as Basis for New Hybrid Ferries Designs, *Journal of Maritime and Transportation Science*, Vol. Spec. edition No.3, 33-48, 2020.
- [2] Bureau Veritas Rules for the classification of Steel Ships, June 2019, Part B Hull and Stability
- [3] ANSYS/LST, LS-DYNA R11, User manual Vol I, II, III, Theory manual; <https://www.lstc.com/products/ls-dyna>
- [4] K. J. Bathe, *Finite Element Procedures*, McGraw – Hill, 1998.
- [5] O. C. Zienkiewicz, R. L. Taylor, *The Finite Element Method*, Volume 1, The Basis, Fifth edition, Butterworth-Heinemann, 2000.
- [6] V. Žanić, J. Andrić, D. Frank, *Structural Optimization Method for the Concept Design of Ship Structures*, International Marine Design Conference-IMDC 2003, Athens, Greece
- [7] P. Riggo, *A Module-Oriented Optimization Tool*, Practical Design of Ships and Other Floating Structures- PRADS 2001, pp.51-58, 2001.
- [8] Hughes, O. F. Paik, J.K.: *Ship structural Analysis and Design*, SNAME, New Jersey, 2010
- [9] Okumoto, Y., Takeda, Y., Mano, M., Okada T.: *Design of Ship Hull Structures*, Springer 2009.
- [10] ...DNV...CSA - Direct Analysis of Ship Structures CLASSIFICATION NOTES No34.1, January 2013
- [11] ...,Bureau Veritas, "2000 Rules, Analysis Based on Three Dimensional Models, Pt B, Ch 7, App1-3", June 2000
- [12] A Zamarin, J Prpic-Orsic, V Coric, *Non-Linear Wave Load of Ship in Head Waves*, BRODOGRADNJA 51 (2), 147-157, 2003.
- [13] H. G. Payer, W. Fricke, "Rational Dimensioning and Analysis of Complex Ship Structures", SNAME Transactions, Vol. 102, pp.395-417, 1994.
- [14] Žaja, D., Zamarin, A., Hadjina, M.: *Longitudinal strength of a Container Ship*, Engineering Review, 27(1) 55-66, 2007.