

Hydra-II User Manual

GREENBAY

Wuhan Greenbay Marine Technology Co., Ltd.

1.Tips.....	4
1.1 Disclaimer.....	4
1.2 Notice.....	5
1.3 Intellectual property right.....	6
1.4 Customer service.....	6
2.Controller installation.....	7
2.1 Summary.....	7
2.2 System structure.....	8
2.2 Main controller.....	9
2.2.1 Overview.....	9
2.2.2 Size.....	10
2.2.3 Power Supply.....	10
2.3 Driver Board.....	11
2.3.1 Overview.....	11
2.3.2 Size.....	11
2.3.3 Interfaces.....	12
2.3.4 Power Supply.....	12
2.4 Power Management Board.....	12
2.4.1 Overview.....	12
2.4.2 Size.....	13
2.4.3 Interfaces.....	13
2.4 Equipment Install.....	13
2.4.1 Install Main Controller.....	13
2.4.2 Install Driver Board.....	14
2.4.3 Install Power Management Board.....	14
2.4.4 Install GPS & Compass.....	14
2.4.5 Install Antenna.....	14
3.GCS (Ground Control System).....	15
3.1 Features.....	15
3.2 Software Install.....	15
3.2.1 Install.....	15
3.2.2 Preset.....	18
3.3 Features.....	20
3.3.1 Run Hydra.....	20
3.3.1 Mission.....	22
3.3.2 Planning.....	25
3.3.3 Parameter.....	28
3.3.4 Communication.....	32
3.3.5 Exit.....	33
3.4 Waypoint planning.....	33
3.4.1 Record Track.....	34
3.4.2 Manual Planning.....	34
3.4.3 Automatic Planning.....	35

3.5 Video.....	38
3.5.1 Parameters.....	38
3.5.2 Open/Close.....	39
4.Remote Controller.....	41
4.1 Description.....	41
4.2 Button.....	41
4.3 Precautions.....	42
5.Transport and storage.....	43
6.Maintenance.....	43
7.FAQ.....	44
8. Notice.....	44
9.Warranty / Warranty card.....	45

GREENBAY

1.Tips

1.1 Disclaimer

This product is NOT a toy and is not suitable for children under the age of 18.

The information in this document affects your safety and your legal rights and responsibilities. Read this entire document carefully to ensure proper configuration before use. Failure to read and follow the instructions and warnings in this document may result in product loss, serious injury to you, or damage to your property.

By using this product, you hereby signify that you have read this disclaimer carefully and that you understand and agree to abide by the terms and conditions herein.

Greenbay accepts no liability for damage, injury or any legal responsibility incurred directly or indirectly from the use of this product. The user shall observe safe and lawful practices including, but not limited to, the following guidelines.

1. Damage caused by you are drunk, taking drugs, under the influence of anesthesia, or suffering from dizziness, fatigue, nausea or any other conditions, whether physical or mental, that could impair your ability to operate the production safely.
2. Crashes or fire damage caused by non-manufacturing factors, including but not limited to, pilot errors.
3. Damage caused by unauthorized modification, disassembly, or shell opening not in accordance with official instructions or manuals.
4. Damage caused by improper installation, incorrect use, or operation not in accordance with official instructions or manuals.
5. The subjective intention of the driver causes personal injury, property loss, and so on. Any compensation for mental damage caused by the accident.
6. Damage caused by the use of the products produced by the non our company or the imitation of our products.

7. Compensation for damage caused by driver's misoperation or subjective misjudgment.
8. Damage caused by other parts outside the control of the ship.
9. Knowing that the unmanned ship is in an abnormal state (such as water or other unknown substances and is not properly assembled, the main components are obviously damaged, the parts are obviously damaged or missing), and the damage caused by the forced driving is still damaged.
10. The unmanned ship is in the magnetic interference area, the radio interference area, the government stipulated forbidden area or the driver's field of vision is in the backlight, is obstructed by the barrier, the line of vision is fuzzy, the eyesight is bad and so on, is not suitable for the operation and other unsuitable driving conditions, the damage caused by driving.
11. Manipulate in bad weather, such as rainy days or windy (more than 6 levels), snow, hail and other bad weather.
12. Unmanned ship collision, overturning, fire and explosion, lightning, storms, tornadoes, floods, storms, tsunamis, subsidence, collapse, ice cliff collapse, avalanche, debris flow, landslide, hail, earthquake etc.
13. Any data, audio, or image data obtained by a pilot using an unmanned ship, and damage caused by infringement.
14. Damage to a battery, such as the improper use of a protective circuit, a battery pack, and a charger.
15. The unmanned ship is not far away from electromagnetic interference during its operation, and it has been subjected to friction and collision with other articles during the use process, resulting in accident loss caused by aging or damage of parts, but not timely replacement and maintenance.
16. Other losses that are not within the scope of our responsibility.
17. The loss caused by illegal driving.

1.2 Notice

Prohibiting the use of this product to engage in illegal and criminal activities.

It is forbidden to use this product without carefully reading of all the contents of

this document.

Prohibit the use of this product by non professionals.

1.3 Intellectual property right

The intellectual property of this product and Handbook is owned by us only. Without the written permission, no agency or individual shall be able to copy, copy and publish in any form. In case of reference and publication, it should be noted that the source is our department, and the reference, abridged, and modification of the manual should not be abridged.

1.4 Customer service

service telephone :+0086- 027-8664 5281

This handbook is subject to update without notice.

Website : www.whgbay.com

2.Controller installation

2.1 Summary

The control system of the unmanned ship is made up of GPS module, remote controller, ground station, main control module and motor drive module. It will form highly intelligent autonomous ship with the hull and thruster of the customer. Users can freely choose to use remote controller or ground station to control. Control functions such as remote control, autonomous navigation, speed cruise, automatic return, automatic obstacle avoidance, navigation planning, state monitoring and so on.

Basic characteristics

Thruster type	Power drive
Direction control	Differential steering
Electronic governor	PWM electric modulation
Telecontrol distance	1 km (unobstructed environment)
Digital communication distance	2 km (unobstructed environment)
Electronic compass	Support built-in and external electronic compass
Navigation	Support GPS, Beidou, RTK, etc.
Built-in sensor	Gyroscopes, accelerometers, electronic compass, etc
Working voltage	3S-8S
Working current	80A(The propeller does not supply power through the power management box)
Power waste	< 3W
Working environment temperature	-25°C +65°C
Weight	Master control: 450 g Driver: 500 g Power Supply: 1000 g

Functional characteristics

Multichannel motor drive	The drive controller has a 2 - way PWM signal, which can be extended.
Manual control	You can use the remote control to control the navigation directly.
Automatic navigation	Through the ground station planning route, the control system is operated automatically according to the following route.
Cruise control	Navigate at a set speed, a remote control to control the direction of the voyage.
Automatic obstacle	Automatic obstacle avoidance (support for ultrasonic and

avoidance	radar, non - Standard).
Navigation planning and monitoring	Through the ground station, the navigation path can be monitored, planned and changed in real time.
Out of control protection	Automatic return of communication interruption; automatic return of low quantity of electricity.
Autopilot	The planned navigation mission is returned automatically after the end of the mission.

2.2 System structure

The Hydra II system is composed of main controller, driver board, power management board, COM server ,Radio. The system connection block diagram is as the following .

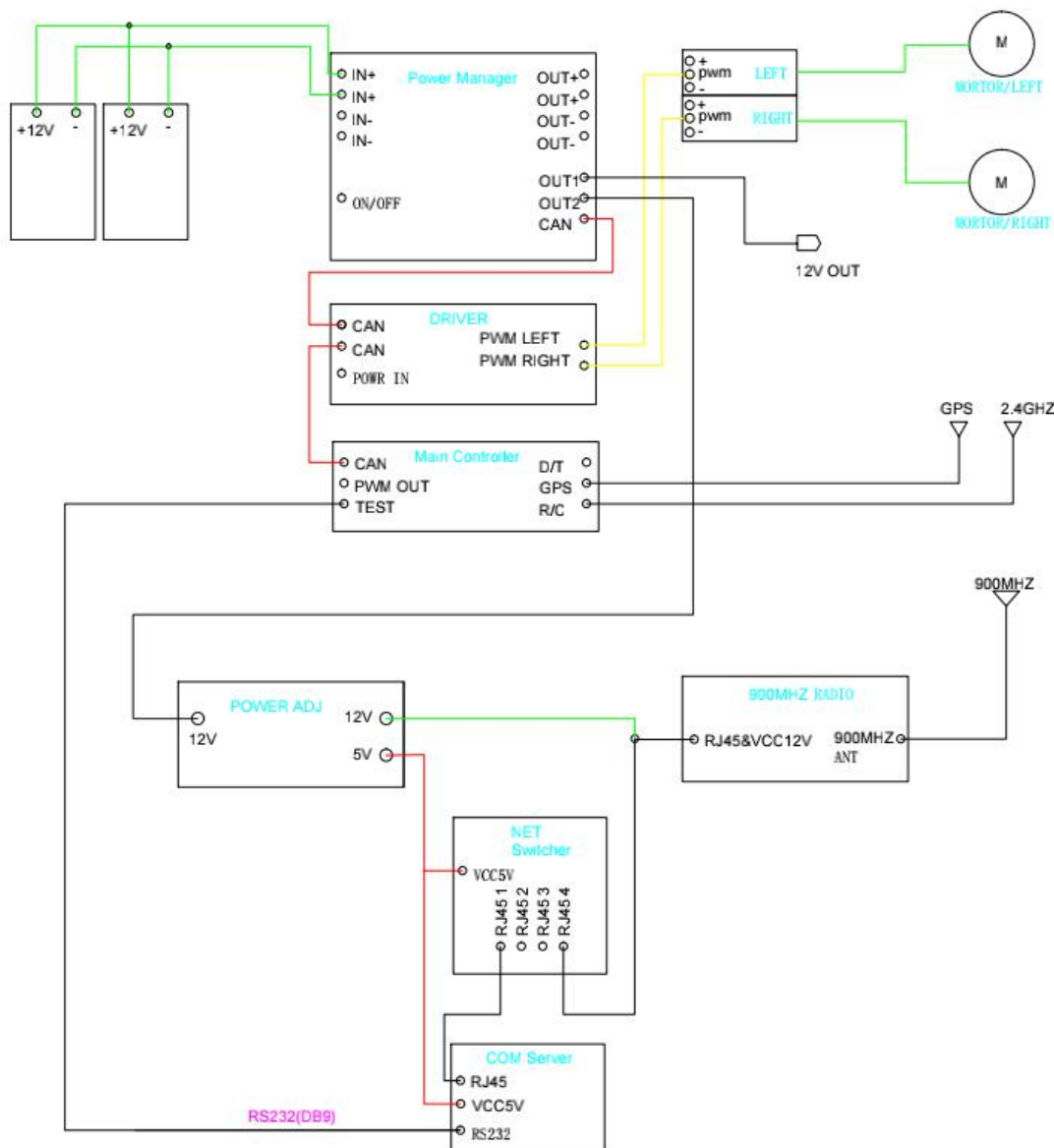

Figure 2.1

2.2 Main controller

2.2.1 Overview

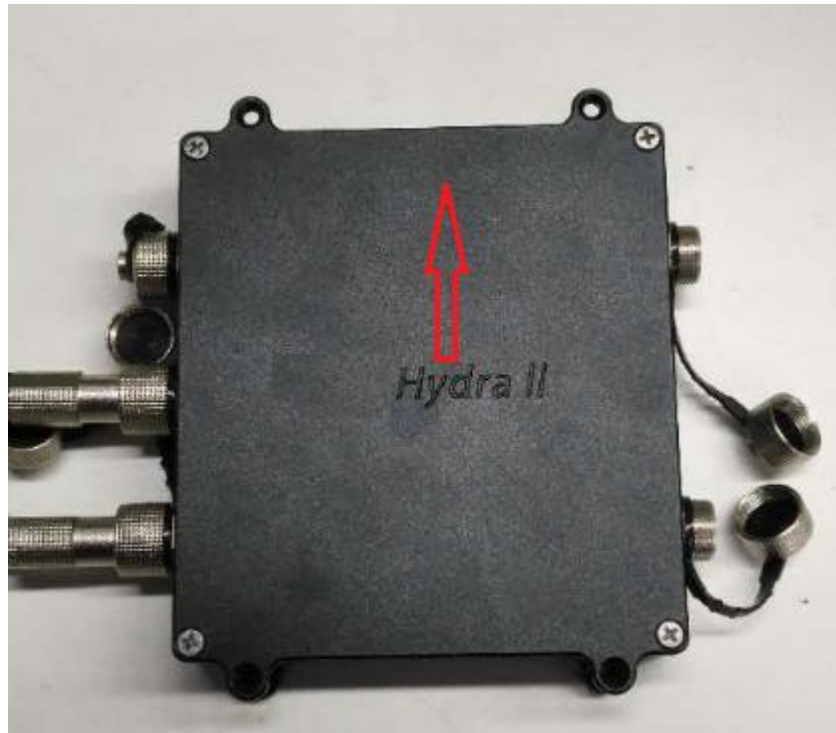

Figure 2.2

2.2.2 Size

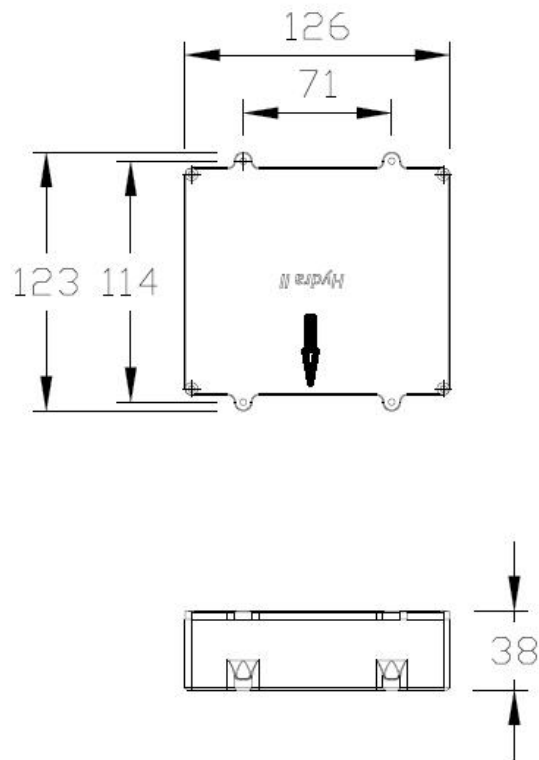

Figure 2.3

2.2.3 Power Supply

The power of the main controller is supplied by the power management board through the CAN bus.

2.3 Driver Board

2.3.1 Overview



Figure 2.4

2.3.2 Size

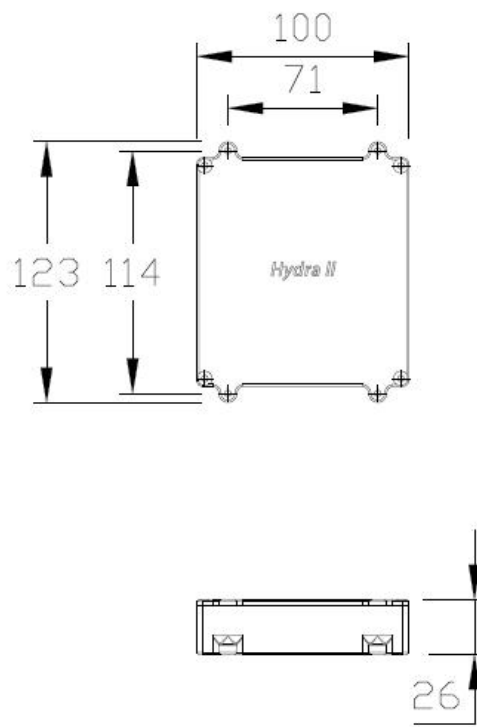

Figure 2.5

2.3.3 Interfaces

Aerial plug	Line color	Characteristic	Interface
PWM1	Black	GND	PWM1
	Red	+5V	
	Yellow	PWM	
PWM2	Black	GND	PWM2
	Red	+5V	
	Yellow	PWM	

2.3.4 Power Supply

The power of the driver board is supplied by the power board through the CAN bus .

2.4 Power Management Board

2.4.1 Overview



Figure 2.6

2.4.2 Size

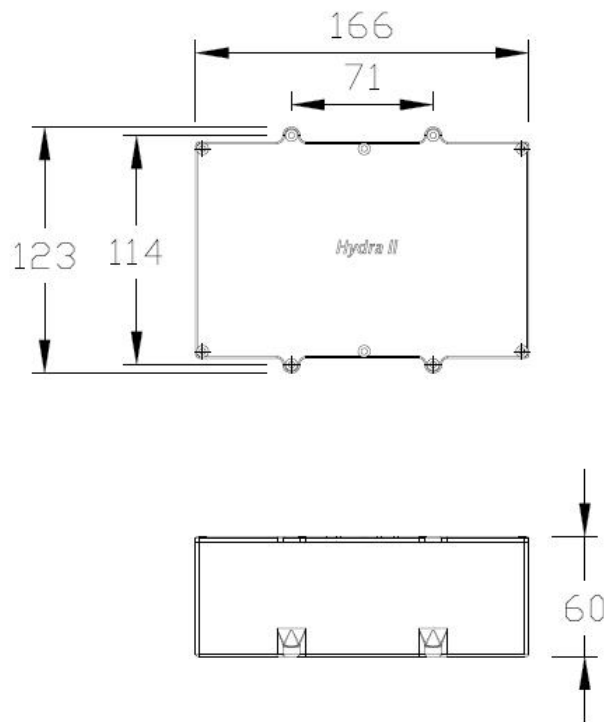

Figure 2.7

2.4.3 Interfaces

Plug	Line color	Characteristic	Interface
IN+	Black	GND	PWM1
	Red	+5V	
	Yellow	PWM	
PWM2	Black	GND	PWM2
	Red	+5V	
	Yellow	PWM	

2.4 Equipment Install

2.4.1 Install Main Controller

The main controller is designed with fixed holes, and make sure the arrow sign is in the

same direction of the head of the boat, and the side with "Hydra II" is upper.

Make sure the main controller is installed far away from the strong magnetic area on the boat.

2.4.2 Install Driver Board

The driver board is designed with fixed holes, and it is better to install it near the propeller so that PWM signal line is more shorter.

The driver board supply the +5V DC power for the electric governor. **If the current is not enough, please use the external power supply to electric governor.**

2.4.3 Install Power Management Board

The power management board is designed with fixed holes, and there is no special requirements.

2.4.4 Install GPS & Compass

The GPS and the electronic compass are integrated, connected to the main controller through the cable.

Make sure the forward direction sign of the GPS & Compass is in the same direction of the head of the boat.

2.4.5 Install Antenna

The 900MHZ antenna is connected to the 900MHZ radio device "RocketM9", which transmits the information between the main control and the ground control system(GCS), and connects to the "TEST" interface of the main controller using a cable.

The 2.4GHZ antenna of the remote controller is connected to the "R/C" interface of the main controller.

3.GCS (Ground Control System)

3.1 Features

operating systems	Windows7 and above
Touch screen	support touch screen.
Map	Online Map Source: Bing Maps, Bing Maps, High German Map, High German Satellite Map, Google China Map, Google China Satellite Map, Google China Mixed Maps; Support the above offline map.
Route planning	supports automatic and manual route planning to support route changes on the fly.
Mission planning	supports sampling, mapping, hydrological surveys and other mission planning.
Status monitoring	can display unmanned flat position, heading, speed, track, remaining power, etc .; can display unmanned working status information, alarm prompts and other information.
Remote control	The ground can be controlled by the joystick unmanned remote control.

Table 3.1

3.2 Software Install

3.2.1 Install

Description: Hydra installation and operation requires Microsoft's Net Framework 4.0 components, so please download Net Framework 4.0 and install before you install Hydra, the official download address is:

<http://www.microsoft.com/en-us/download/confirmation.aspx?id=17718>

Follow-up will be in the installation package to the Net Framework components to install.

1) Run the Hydra installation file.

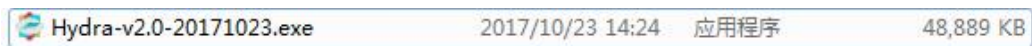

Figure 3.1

2) Enter the welcome page of the installation wizard and click the "next" button.



Figure 3.2

3) Select the location of the software installation, click the "next" button.

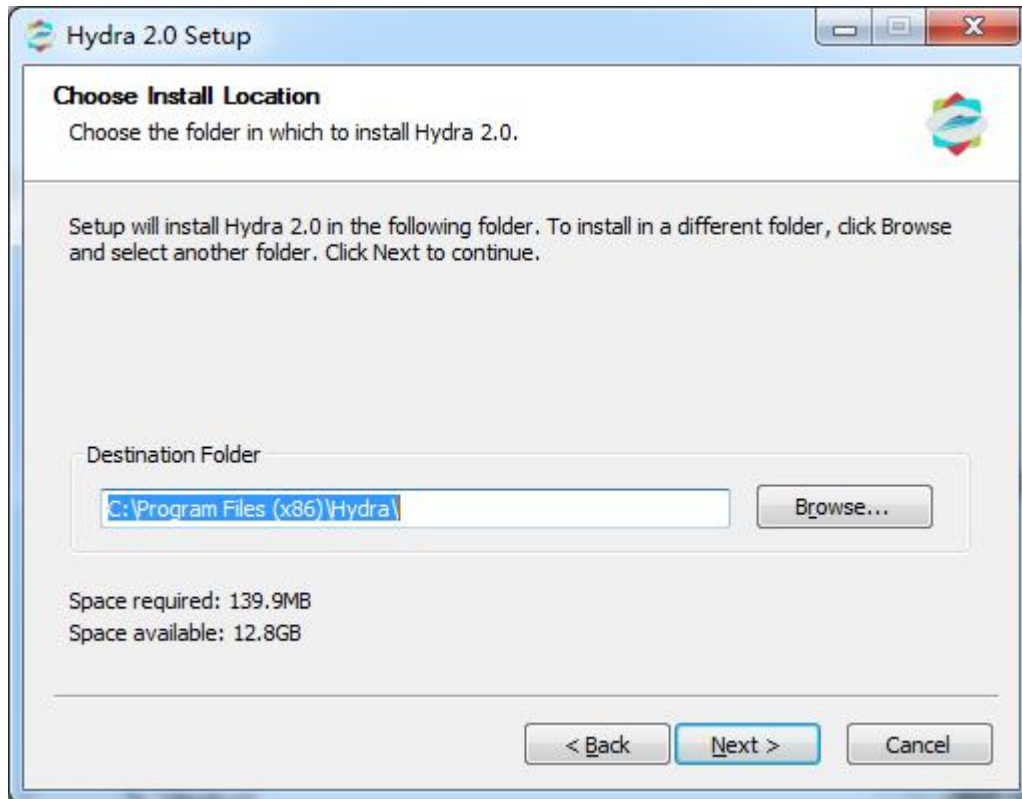

Figure 3.3

4) Enter the installation progress interface.

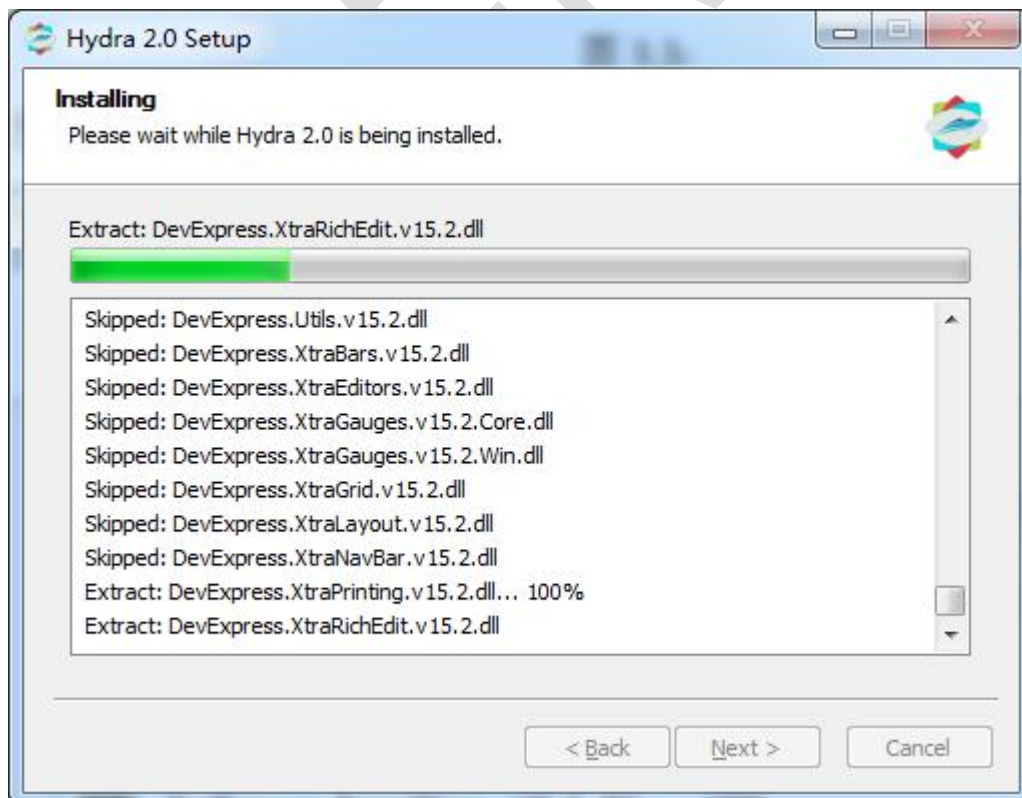

Figure 3.4

5) Click the "finish" button and create shortcuts on the start menu and the desktop after the

program is installed.

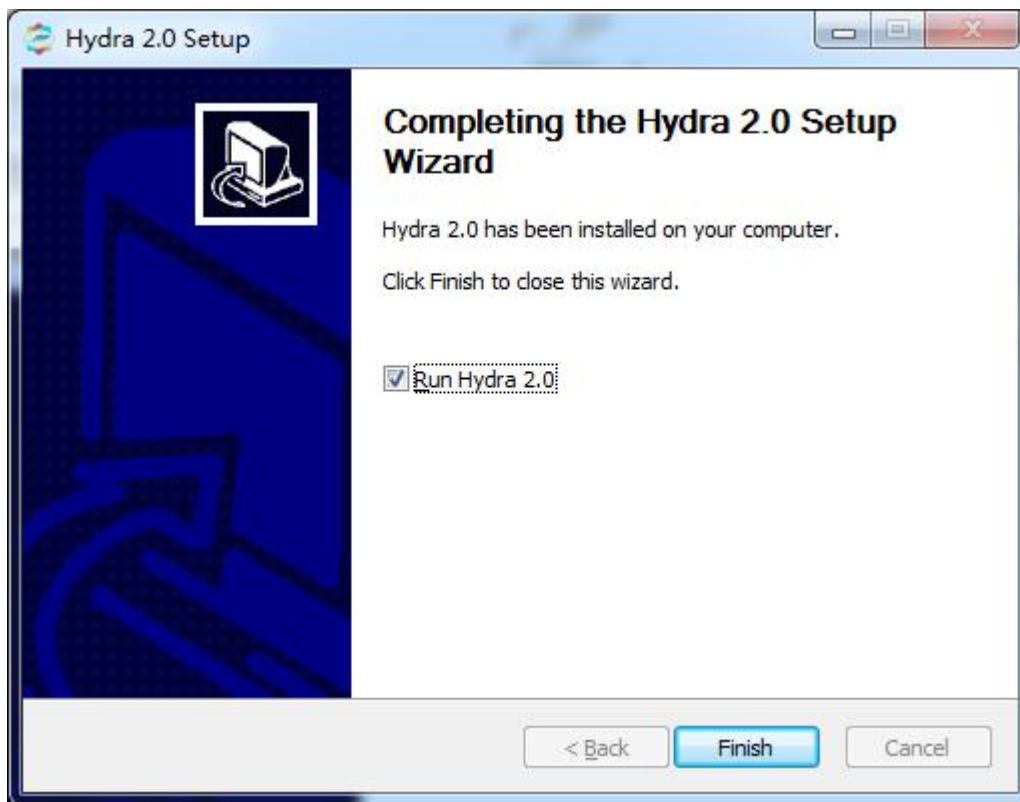

Figure 3.5

3.2.2 Preset

Before using the ground station software, you need to make some settings.

3.2.2.1 Local IP change

In the local computer's control panel \ network and Internet \ network connection, select the local connection properties.

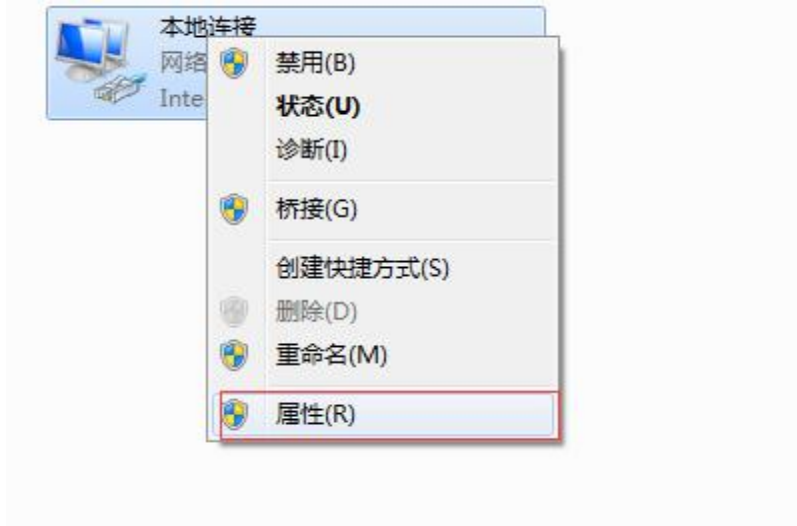

Then select Internet Protocol version 4 (TCP / IPv4) and click Properties



Set the IP address to: 192.168.1.18, Subnet mask: 255.255.255.0,

3.2.2.2 Virtual serial port software settings

First download someone virtual serial software (download address: <http://www.usr.cn/Download/31.html>) and then installed in the local computer. Open the virtual serial software, click the Add button, pop-up window as shown.

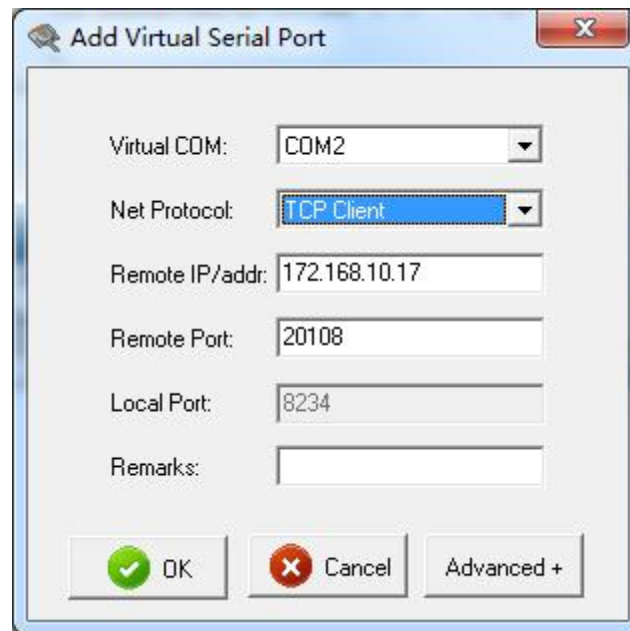

Add the serial port as follows: (serial number can be free to choose)

- ✧ Serial signal: surveying ship data transmission
- ✧ Serial port number: COM4
- ✧ Network protocol: TCP Client
- ✧ Target IP: 192.168.1.18
- ✧ Target port: 7000

3.3 Features

Hydra Ground Station software has two display styles: "Window Mode" and "Full Mode". Which window mode can zoom main window (win7 style), full mode does not support the zoom window (win10 style).

3.3.1 Run Hydra

Execute the installed "Hydra Unmanned Ground Station" software and enter the startup mode selection interface, as shown in figure 3.9:

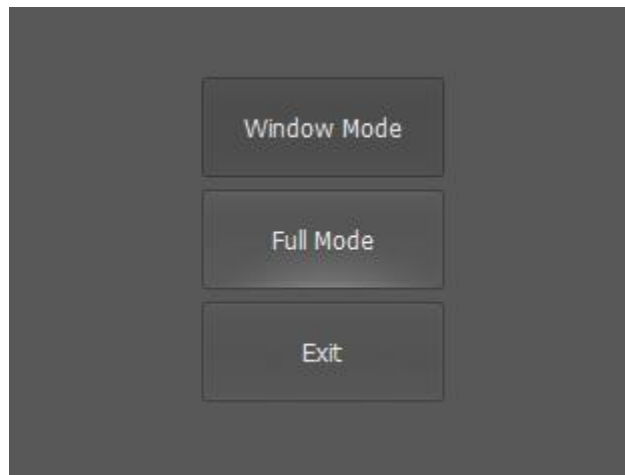

Figure 3.9

According to the need, select the appropriate style.

1) Select "window mode", enter the main interface win7 style, as shown:

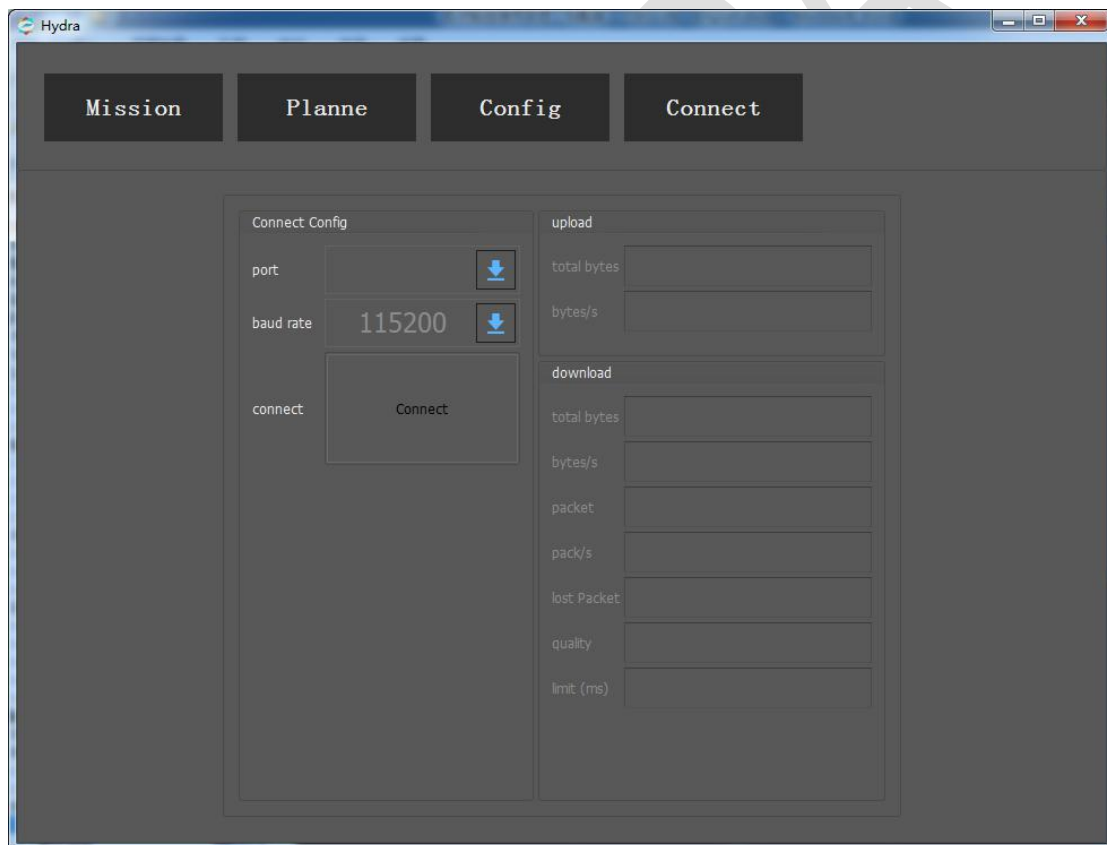

Figure 3.10

2) Select "Full Mode" (touch screen mode), enter the win10 style of the main interface, as shown in Figure 3.11:

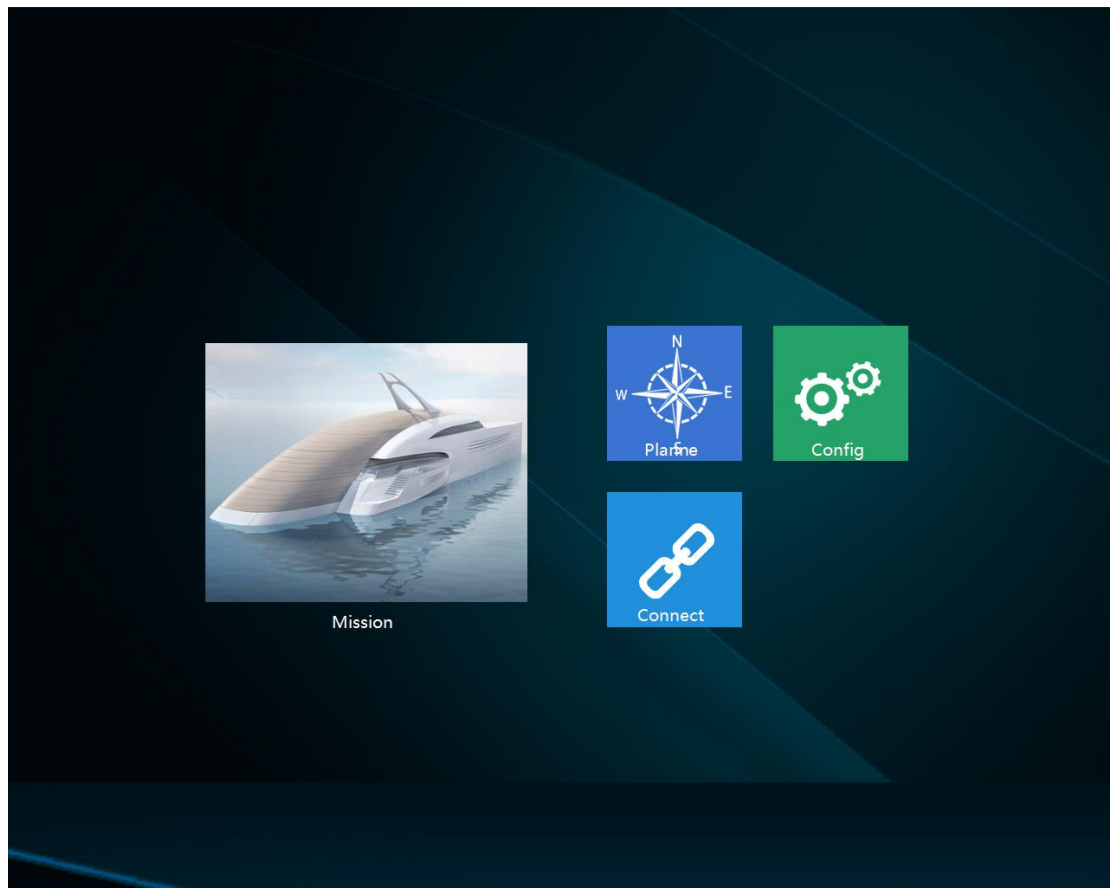

Figure 3.11

NOTE: The follow-up operation in "Window Mode" or "Full Mode" is the same. The following is described by taking " Full Mode" as an example.

3.3.1 Mission

The navigation master interface shows unmanned navigation routes and boat status information and supports real-time control as well as live video viewing. Interface mainly by the "status bar", "speed setting", "map", "control buttons" and other components, the following will be described.

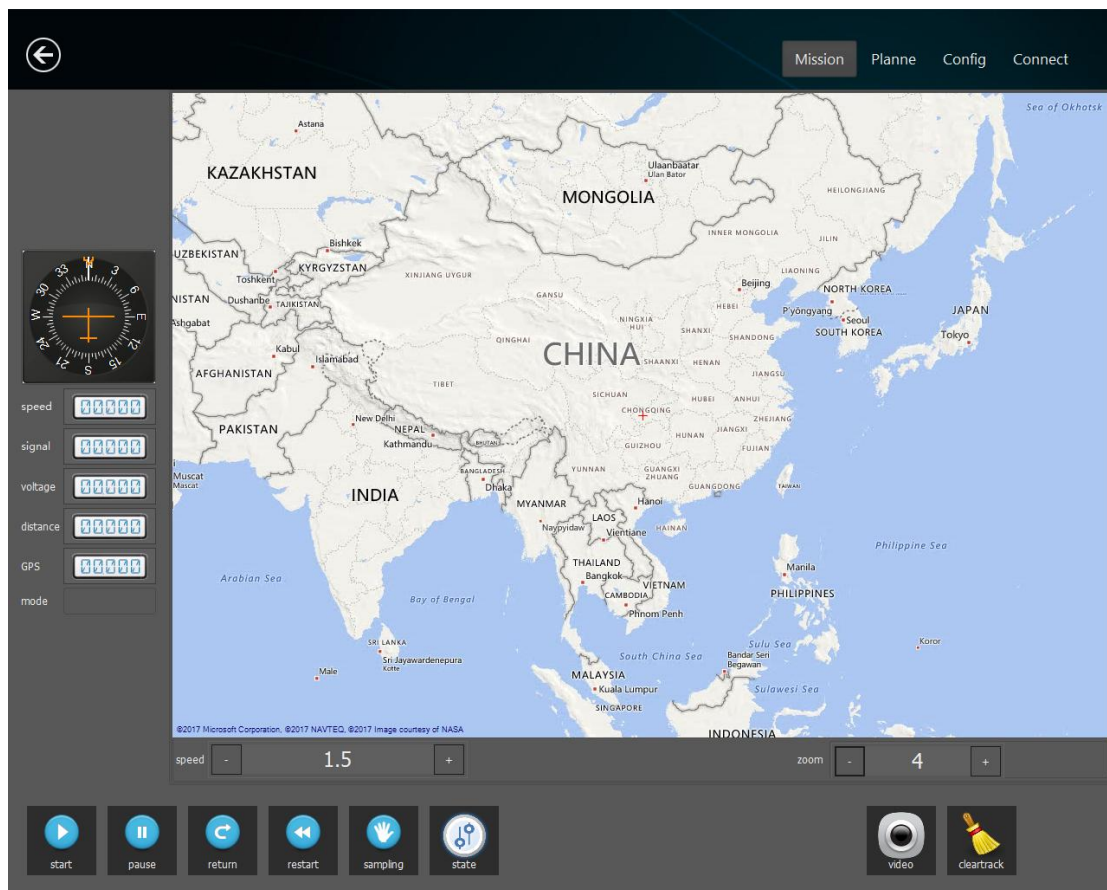

Figure 3.12

Button bar description

No.	Button	description	note
1		After planning the task and sending it to the ship control, click on the Start Task button and the USR will perform the planned task.	
2		Suspend the ongoing task.	
3		Click the button, the USR will be based on the "return mode" set the way to automatically return to Home point. The default is "homecoming".	CAUTION: USR should be used with caution when there is an obstacle in the straight line between the current location and the Home point.





No.	Button	description	note
4		Switch to remote control mode.	
5		Manually sample.	
6		The real-time status of the sample is shown on the right side of the window.	
7		Real-time video surveillance.	Need to load with PTZ camera
8		Clear the navigation track on the map.	

Table 3.2

Ship control status information bar

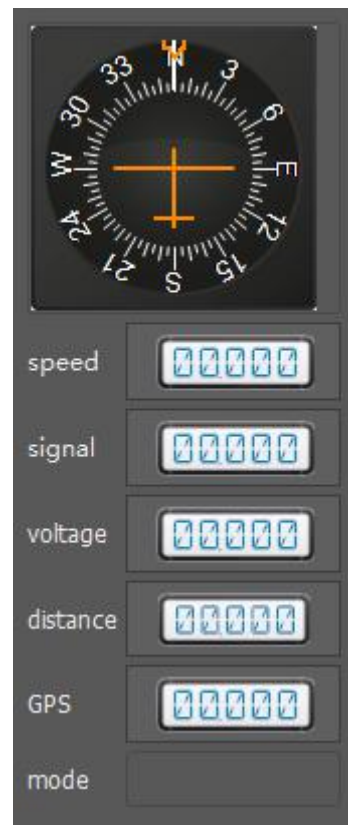

Figure 3.13

The status bar displays the following information in real time:

- ✧ Compass: electronic compass ship control information;
- ✧ Speed: unmanned cruise speed, in m/s;
- ✧ Signal: communication quality, the unit% percentage. 100% is the best, no packet loss;
- ✧ Voltage: ship-controlled real-time voltage, the user can determine the battery according to this data usage;
- ✧ Distance: the distance from the current point to the next waypoint in m or km;
- ✧ GPS: GPS satellite coverage number;
- ✧ Mode: USR's current navigation mode.

3.3.2 Planning

Mission planning interface is mainly used for planning unmanned routes and tasks.

The interface is mainly composed of "navigation bar", "map" and "waypoint list", as shown in Figure 3.14:

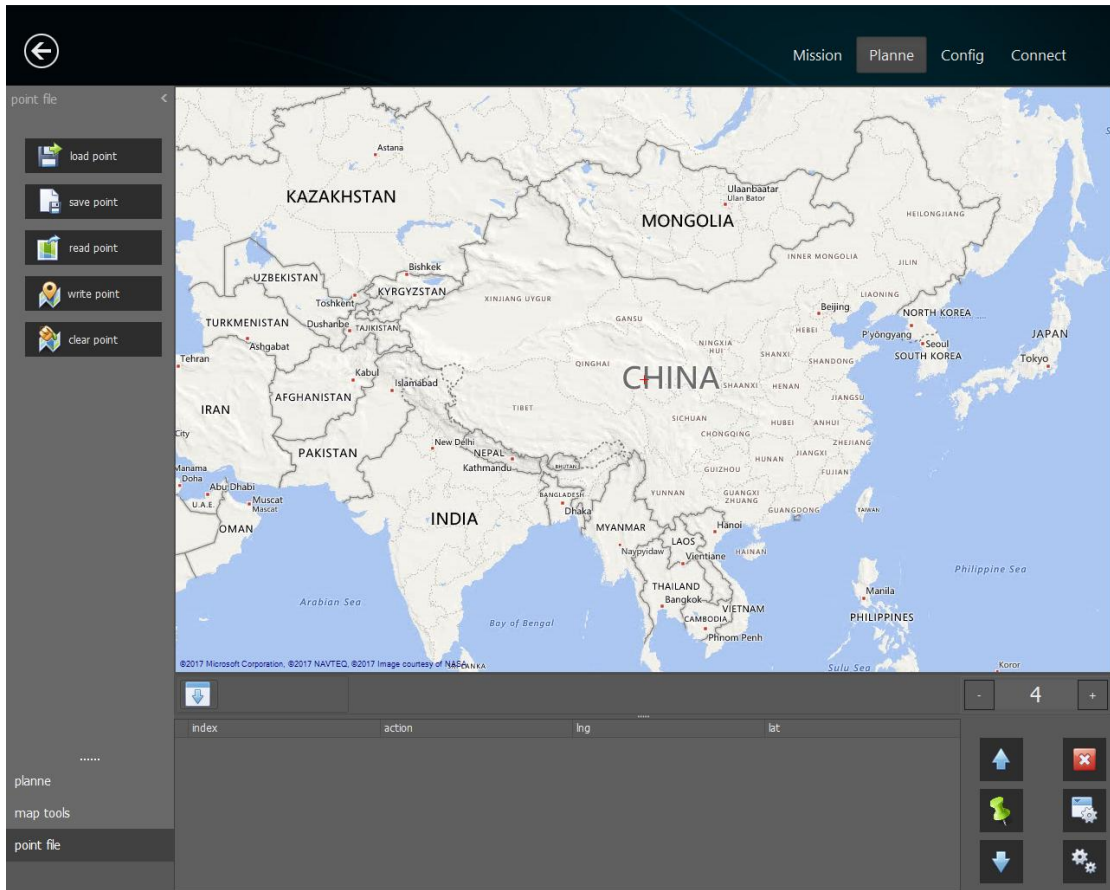

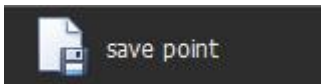
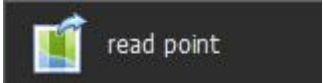

Figure 3.14

Among them, the "navigation bar" in the left is divided into three parts:

- ✧ Points file: save or load waypoint and route planning data;
- ✧ Map tools: conventional map tools, such as ranging, etc.
- ✧ Planne: Support automatic or manual planning of way line data.

1. Navigation bar - Way point file

Index	Name	Meaning	Remarks
1	 load point	Load the way point file saved at the PC end.	A file with a default suffix of.GWP
2	 save point	Save the planned navigation points and routes to the PC end.	A file with a default suffix of.GWP
3	 read point	Read the navigation points and routes stored in the unmanned ship's master control, and display it on the map.	



Index	Name	Meaning	Remarks
4	 write point	The planned points and routes are kept in the master control of the unmanned ship.	
5	 clear point	Remove the existing navigation points and routes.	

Table 3.3

2.Navigation bar - map tool







Index	Name	Meaning	Remarks
1	 save offline map	Save the current map data	offline map
2	 save track	The running track of the ship will be recorded when selected.	Navigation range hints
3	 map follow	The map center point will move with the ship in sync	
4	 clear track	Clear the track of the record	
5	 map measure	Measure the distance between two points on a map	
6	 read DXF	Navigating data planning files in XDF format	

Table 3.4

3.Navigation bar - task planning



Index	Name	Meaning	Remarks
1	 mission planne	When checking, the task data will be generated automatically according to the planned area range, the point interval and the angle.	
2	 range & point	When clicking on the map, clicking on the map will produce an area or a point.	
3	 keep point	Record the planned data in the point list	

Table 3.5

4.Wap Point toolbar

The navigation point toolbar will show detailed orders for planning routes, such as navigation points, return flights, and so on. The button can adjust the order of the task, delete the specified navigational point, and view the details of the task, while the task parameters can be modified.







Index	Name	Meaning	Remarks
1		Delete wap point.	
2		Set the type of the navigational way point.	Two types of support for sampling and navigational points
3		Set the mission parameters of the navigational point.	Support sampling parameter settings
4		Move the way point up.	Changes in the sequence of way points will change the route
5		Move the way point down.	
6		Set the selected navigational point for the current navigational way point	

Table 3.6

3.3.3 Parameter

The parameter setting interface is used to set up the basic parameters. It includes software setting, remote control check, input / output check, route mode.

1) Software Config

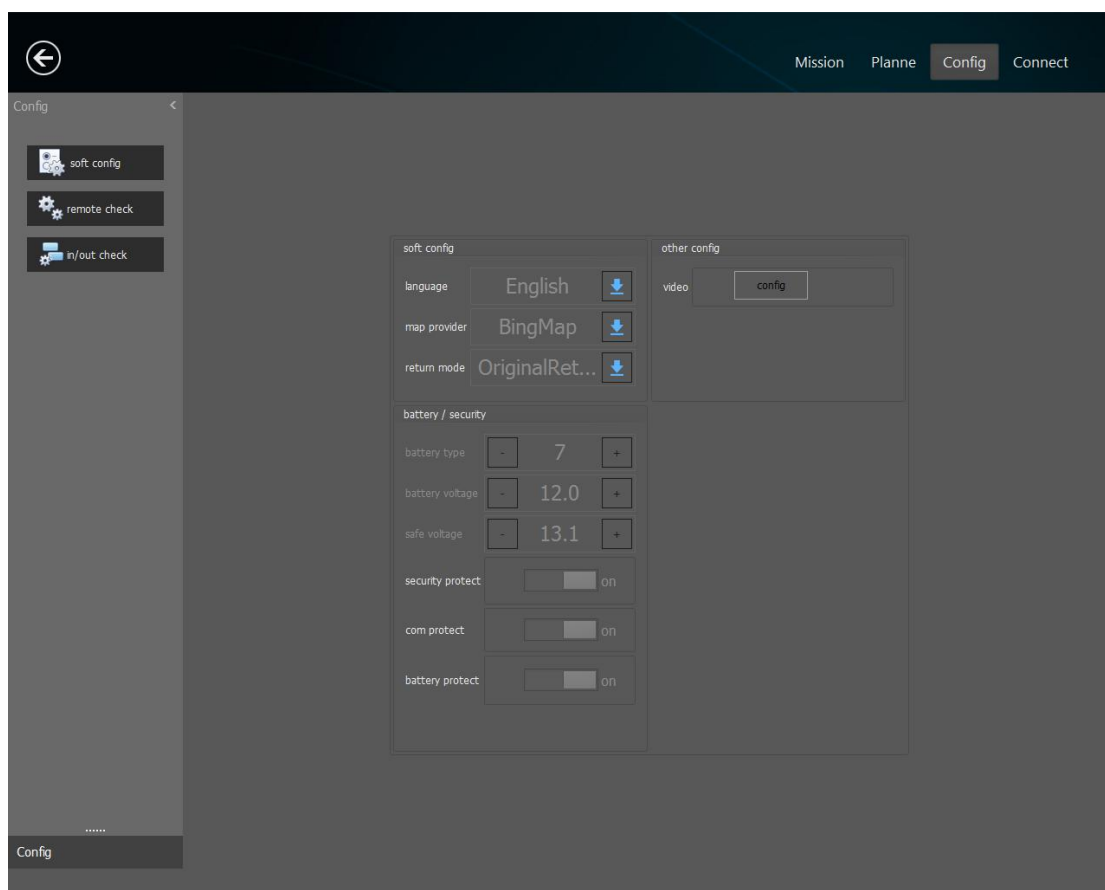

Figure 3.15

Function Description:

Index	Name	Meaning	Remarks
1	Map source	The map sources we choose include: Bing Ying map, Bing Ying satellite map, Gao de map, Gao de satellite map, Google China map, Google China satellite map, Google China mixed map.	
2	Return mode	Select the return mode: straight line return, original road return.	
3	Restart the task	Clicking the setup button, the unmanned ship will re - execute the current task.	
4	Video config	Configure the video related parameters.	

Index	Name	Meaning	Remarks
5	Battery type	Battery type selection: 1~10	
6	Battery voltage	Standard voltage for battery type.	
7	Residual voltage	When the voltage is lower than the set value, the fault protection is triggered.	
8	Residual electricity	When the amount of electricity is lower than the set value, the fault protection is triggered.	
9	Remote control fault protection	When the remote controller loses connection, it triggers fault protection.	
10	Fault protection of ground station	When the ground station loses connection, it triggers the fault protection.	
11	Battery protection	When the current voltage is less than the battery voltage set, the protection will be triggered.	

Table 3.7

2) Remote controller check

After accessing the remote controller correctly, click the start calibration button to record the remote control stroke automatically. When the calibration is completed, click "finish the calibration", and maintain data to ship control. As in Figure 3.16 below:

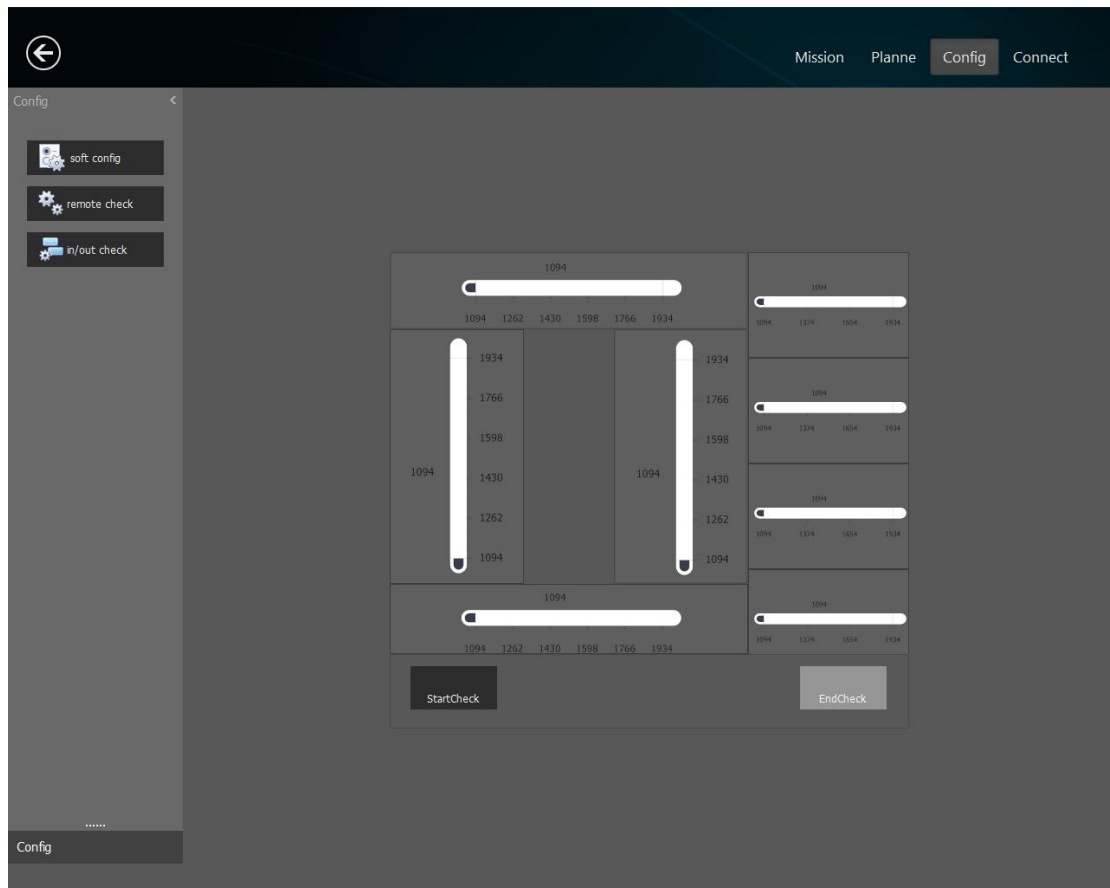

Figure 3.16

3) Input / output check

After accessing the remote controller correctly, we operate the rocker and observe the feedback information of controller input and steering output, which is used to assist in judging whether the remote controller works normally and travel. As in Figure 3.17 below:

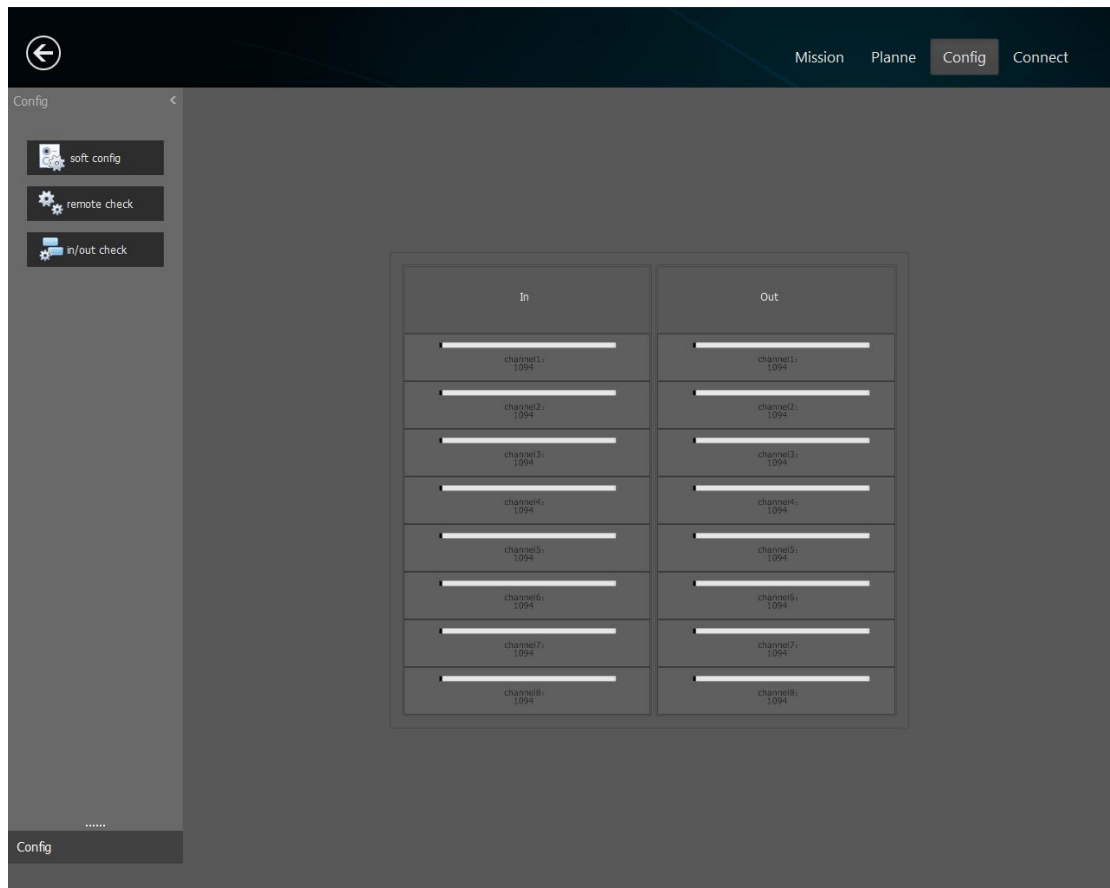

Figure 3.17

3.3.4 Communication

Start Hydra ground station software, click on the main toolbar above the "Connect" button, pop-up dialog box.

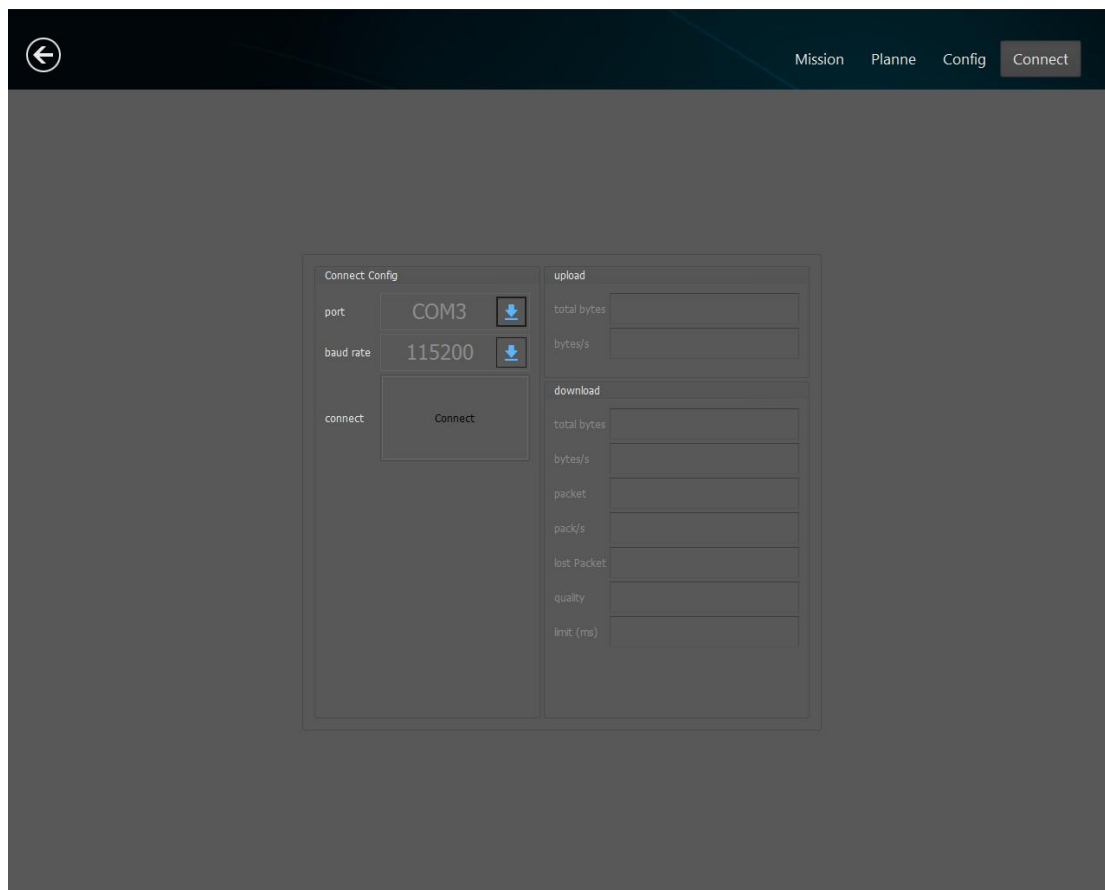

Figure 3.19

If the connection is successful, the "Connect" button will change to "Disconnect", and the uplink and downlink data communication will be displayed in real time, as shown in Figure 3.19.

3.3.5 Exit

"Full mode" style interface, click the right button of the mouse, or press the ESC key, the



upper right corner of the ground station pops out, click this button to exit the ground station software.

3.4 Waypoint planning

There are two ways of route planning. The first is to manually determine the navigational points and routes on the map, and the third is automatically planned according to the selected

areas on the map. At the same time, an auxiliary function (similar to an electronic enclosure) is provided for the boundary of the planning area according to the real-time navigation trajectory of the unmanned ship.

3.4.1 Record Track

1) After connecting main controller successfully, select the "save track" and "map follow" functions under the map tool.

2) The remote control is used to manually control the unmanned ship to navigate along the boundary of the tested area. The ground station software will record the range of navigation on the map, and it will be used as an auxiliary reference for the planning area, figure 24.

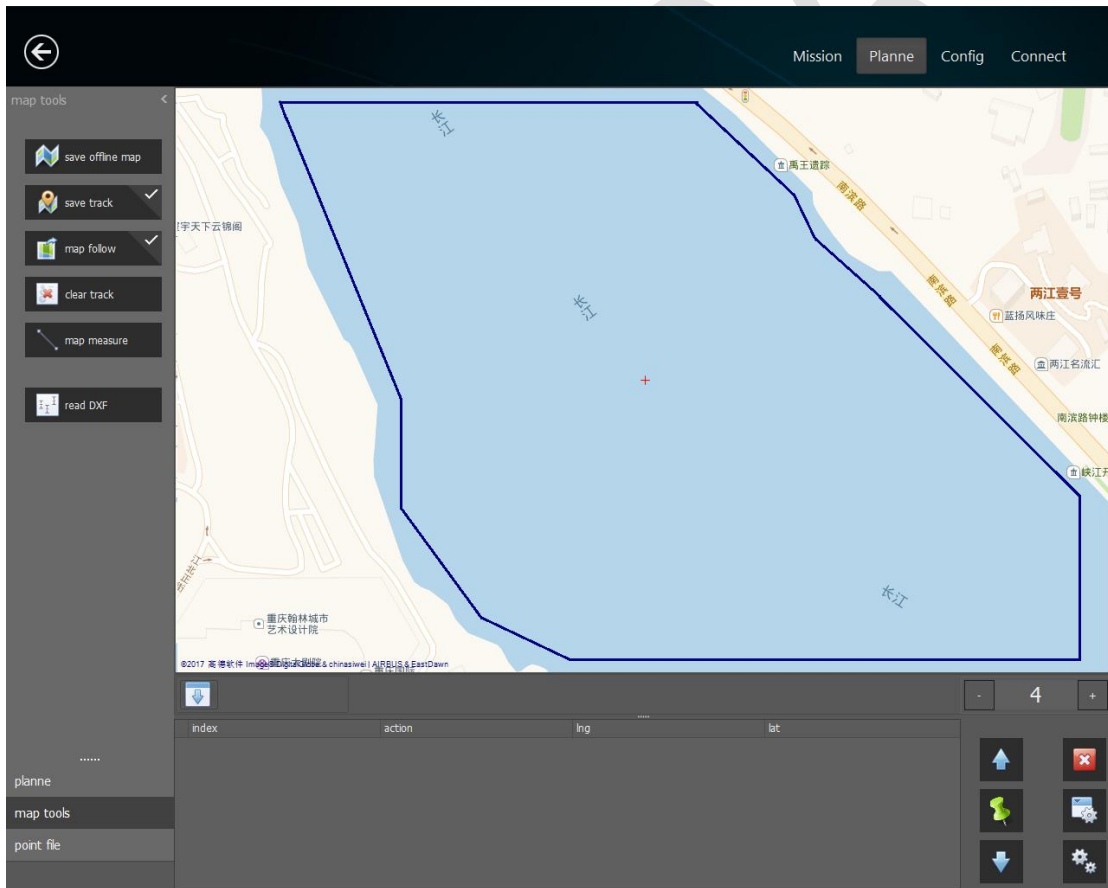

Figure 24 Save Track

3.4.2 Manual Planning

1) Enter the "mission plan" interface, check the "range or waypoint", then manually set the

navigation points on the map according to the water needed to be tested, and draw the corresponding route on the map according to the order of voyages, figure 25.

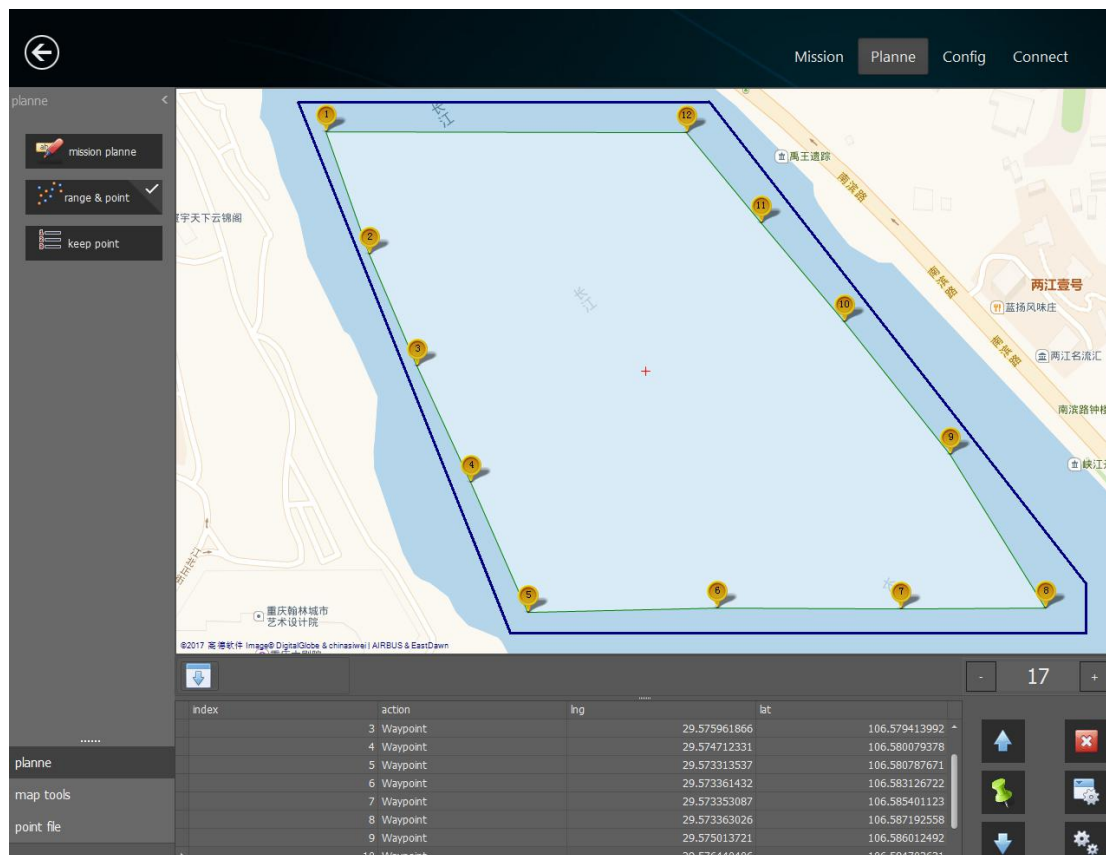

Figure 25 Manual planning

2) The task of editing the navigational point in a list control that can be sent under the task plan interface is based on the need.

3) After the completion of the plan, we choose "write on the waypoint" on the waypoint File menu, and save the waypoint information to the unmanned ship, then we can "start" automatic navigation in the main navigation.

3.4.3 Automatic Planning

1) In the task planning column, check the function of "range or waypoint", and determine the navigation area according to the appropriate map scaling ratio (recommended 16 times or more), figure 26.

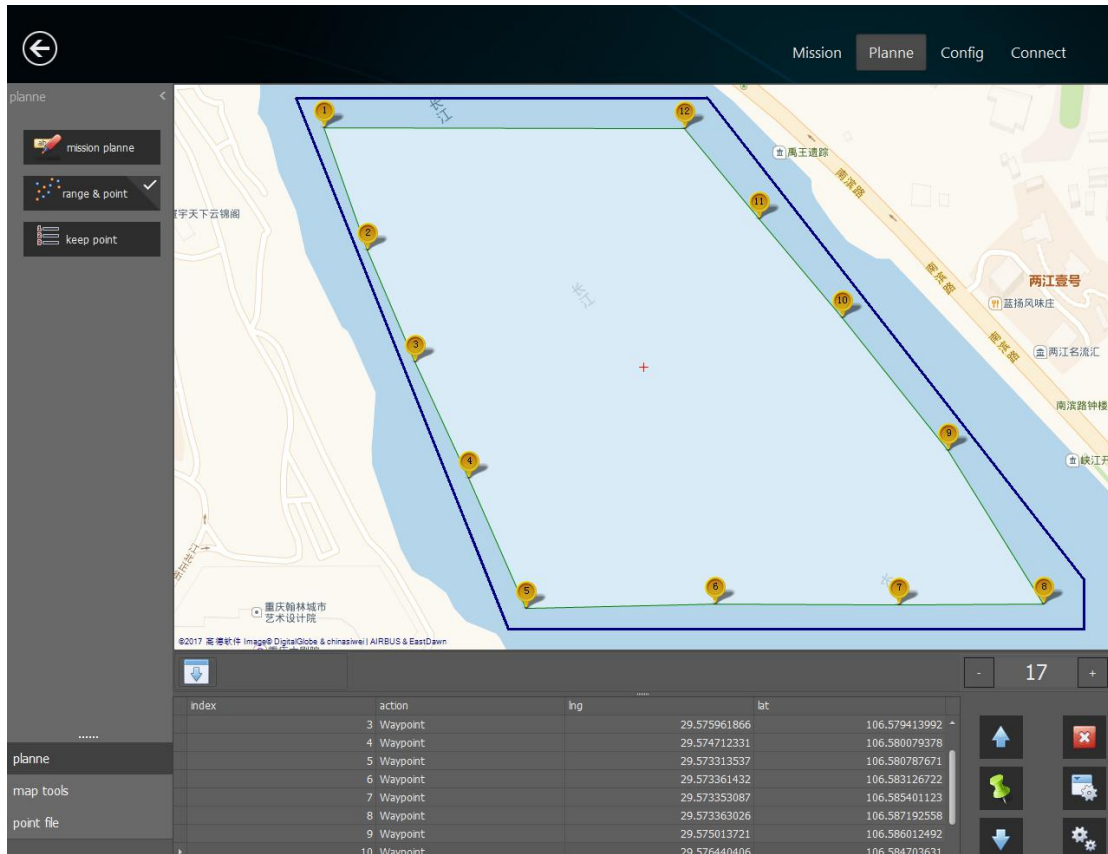

Figure 26 set range

2) In determining the scope of a polygon, can use the automatic planning function to the planning of the covering area: check the "mission planning", the interface appears to the right of automatic planning parameters input box; input interval, angle, start position, and then click on the "planning" button, will have to meet the conditions of the planning point planning and automatic line, figure 27.

- ✧ An interval: said navigation route width (in meters), usually set to 10 meters.
- ✧ In perspective: according to set the angle point sequence generation.
- ✧ In the start position: task starting point location, select the upper left, lower left, upper right, lower right".

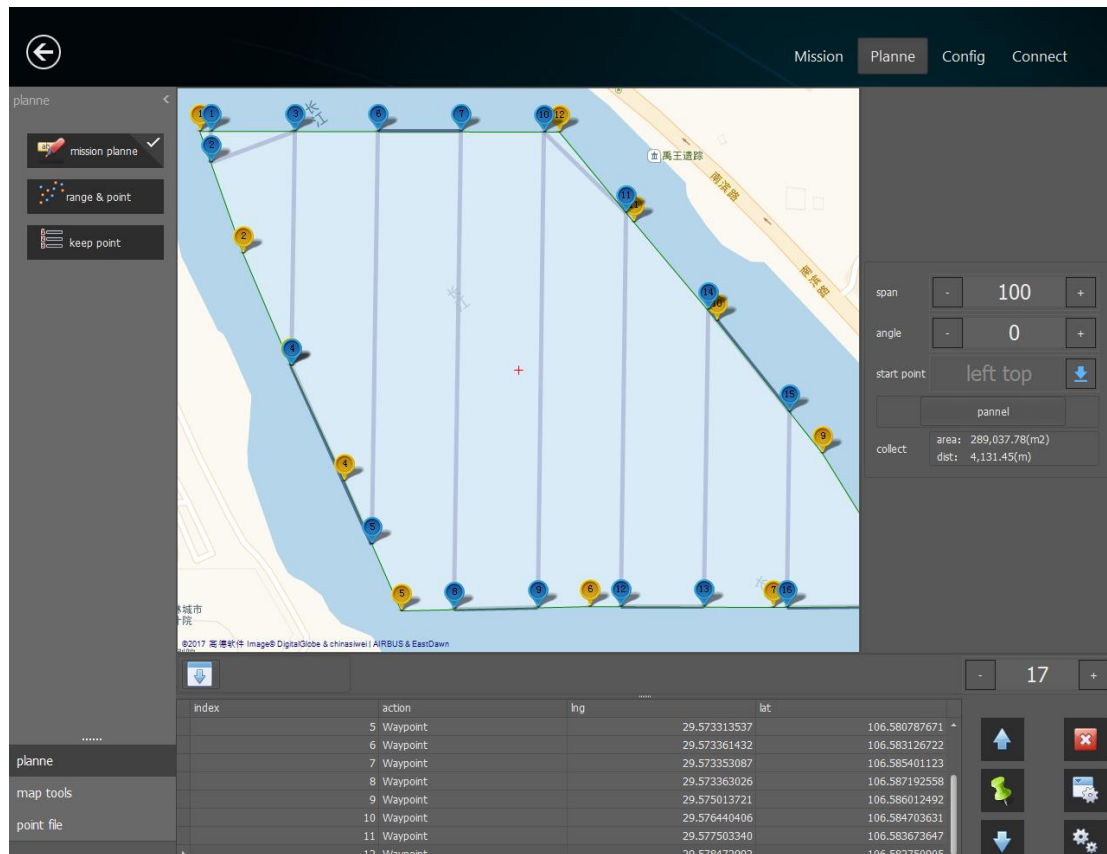

Figure 27 Automatic planning

3) After the plan is confirmed, click the "record navigation point" button to convert the planning point to the navigational point and route, figure 28.

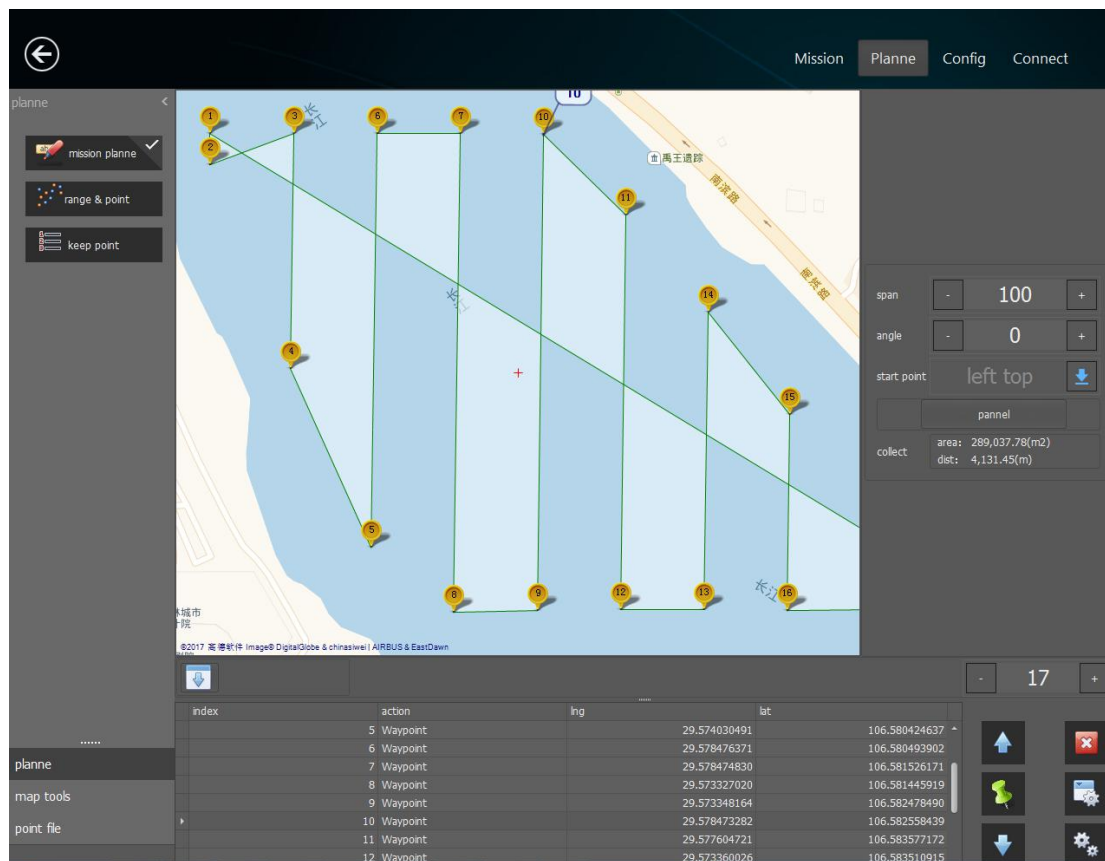

Figure 28 Save Waypoint

4) After the completion of the plan, the "write navigation point" is selected in the navigation point file bar, and the information of the way point is saved to the unmanned ship.

5) At the main control interface, clicking on the "start" Task button, the unmanned ship will automatically navigate along the route. (the main control of the navigation can be set up for the return terminal.)

3.5 Video

3.5.1 Parameters

In the software settings page under parameter configuration, click video "config" to set up the video parameter configuration window, the target IP is set to 192.168.1.64, port: 8000, login name: admin, password: w12345678.

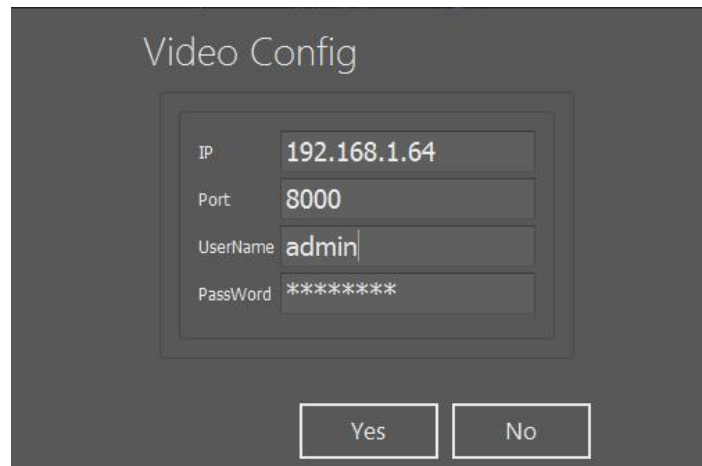

3.5.2 Open/Close

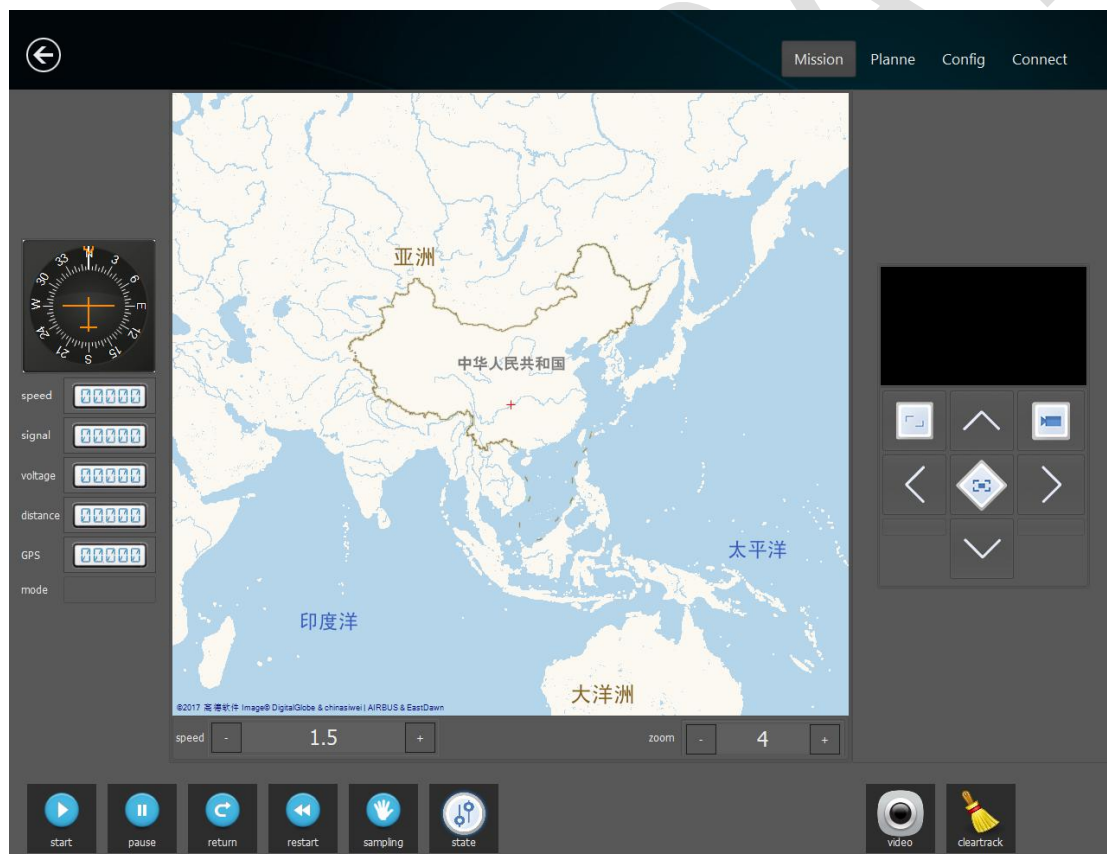

Figure 29 Use Video



Video button: open or close the video. When the video is open, a small video window will be opened on the right side of the screen, as shown in Figure 29.



Figure 30 video window

The video operation button explains:







Index	Name	Meaning	Remarks
1		Grab the current screen and save it as a picture	
2		Open or close videotape	
3		Pop-up video window	
4		Camera cloud platform moving Up	Support for cloud platform
5		Camera cloud platform moving Down	
6		Camera cloud platform moving Left	
7		Camera cloud platform moving right	

Figure 31 Video button

4.Remote Controller

4.1 Description

The remote controller and the receiver must be paired. The control mode of the default remote control is American hand (left-handed throttle) when he is out of the factory. The remote control conforms to the CE standard.

The maximum communication distance of the remote control is 1000 meters.

There is no barrier between the telecontrol antenna and the receiver antenna, otherwise the distance will be greatly shortened.

4.2 Button

The functions of each key of the remote control are shown in Figure 4.1:



Figure 4.1: Remote control

- ① Power switch: open and close the power of the remote control.
- ② Propeller control rocker: push the throttle upwards to control the unmanned ship.

③Unlocking switch: when the lever is at the top position, it is locked. The unmanned ship is locked. The motor will stop immediately, unable to drive. When the lever is in the middle or at the bottom, it will be unlocked. The remote controller or the ground station can control the ship's driving.

④Mode selection: automatic mode toggle rod in the top back, the ship will return to the independent HOME; toggle rod in middle position for cruise ship model, will advance to set the speed and direction of the ship can be controlled by the direction of the rod; toggle rod in manual mode for the following, operator manual control of unmanned boat.

⑤Direction control rocker: control the ship to the left and right.

4.3 Precautions

Before using the remote control, keep the remote control in the following state:

- 1.The propeller controls the rocker (2) and is in the "middle" position.
- 2.Unlock the switch (3) and keep it in the middle or lower position.

5.Transport and storage

1. the equipment for the packing and transportation is transported by the conventional means of transportation.
2. in the course of transportation, it should be prevented from severe shock, rain and sun exposure.
3. the products after packaging should be stored at room temperature of -5 ~ 55 C, relative humidity no more than 90%, atmospheric pressure 760 hPa to 1060 hPa, no corrosive gas and well ventilated room.



Matters needing attention

6.Maintenance

The main control module and the driving module are all installed in the control cabin. The waterproof measures have been done well before the factory is out of the factory. Because of the influence of remote-controlled ship in water work and air humidity, it is inevitable to generate humid and hot air in the control cabin. Therefore, in order to prevent damage of damp heat air to control circuit, regular maintenance is needed.

- 1、 In the long run, seal treatment should be carried out. After packing, it is kept in a cool, dry and corrosive environment.
- 2、 The abnormal phenomenon or failure of the product must be promptly notified to the technical personnel of the factory or the local dealer. It must be maintained by a special person and not to be repaired without authorization.
- 3、 After each use, the hull and module can be dried by a water absorbent towel.
- 4、 The daily storage of the remote control ship should be selected in the cool

and dry place, and the ventilation should be kept.

7.FAQ

1.How does the ground station connect the equipment repeatedly and how to deal with it?

Please check the normal work of the device and restart the PC client reconnection.

2.The remote control can not control the unmanned ship, how to deal with it?

Check whether the switch on the remote control is open, and the unlocked switch is in the unlocked position.

3.How do you deal with the unmanned ship?

Check whether the communication is normal, the battery voltage is lower than the protection set value.

8. Notice

Please keep the main controller level when starting.

9.Warranty / Warranty card

1. From the day of purchase, the products enjoy a year's free warranty on the basis of the shopping invoices..
2. we will not provide a free warranty for the failure caused by the individual reasons of the following users.
 - A) malfunction caused by unauthorized disassembly and reloading of the product;
 - B) malfunction caused by careless fall in the process of use and handling;
 - C) failure due to lack of reasonable maintenance;
 - D) failure to operate in accordance with the correct instructions of the instructions;
 - E) failures caused by improper repair of the non - million - mile high authorized repair shop.
3. the repair service outside the warranty will be charged according to the regulations.
4. in the request for warranty service, please consult customer service department 10000 high-tech companies, the company can provide equipment components can be specified by the manufacturer must repair materials (due to some technical information relating to the company's business secrets, such as the need to please apply to the company).
Repair parts continue to be provided within 10 years after the product is stopped.

In order to keep improving this product, we reserve the right to change the part without previous notice. Please read this manual carefully to avoid potential operating errors.